

# SNAP CIRCUITS®

# GREEN

## Alternative Energy

Projects 1-129

SNAP CIRCUITS®

AGE  
8 - 108

Instruction Manual

Elenco® Electronics, Inc.

## Table of Contents

For the best learning experience, do the projects in order.

|                                       |       |                               |         |
|---------------------------------------|-------|-------------------------------|---------|
| Basic Troubleshooting                 | 1     | Advanced Troubleshooting      | 9, 10   |
| Parts List                            | 2     | Project Listings              | 11, 12  |
| How to Use It                         | 3, 4  | Projects 1 - 129              | 13 - 77 |
| About Your Snap Circuits® Green Parts | 5 - 7 | Other Snap Circuits® Projects | 78      |
| DO's and DON'Ts of Building Circuits  | 8     |                               |         |



**WARNING FOR ALL PARTS WITH A  SYMBOL** - Moving parts. Do not touch the motor or fan during operation. Do not lean over the motor. Eye protection is recommended.



**WARNING: SHOCK HAZARD** - Never connect your Snap Circuits® set to the electrical outlets in your home in any way!



**WARNING: CHOKING HAZARD** - Small parts. Not for children under 3 years.

Conforms to all applicable U.S. government requirements.

**WARNING:** Always check your wiring before turning on a circuit. Never leave a circuit unattended while the batteries are installed. Never connect additional batteries or any other power sources to your circuits. Discard any cracked or broken parts.

## Basic Troubleshooting

1. The battery (B4) will only work if it is charged. Project 3 shows how to recharge it.
2. Most circuit problems are due to incorrect assembly, always double-check that your circuit exactly matches the drawing for it.
3. Be sure that parts with positive/negative markings are positioned as per the drawing.
4. Be sure that all connections are securely snapped.
5. Sometimes the motor or solar cell is mounted on the pivot stand so its angle to the sun or wind can be adjusted. The pivot stand base, post, and top should be assembled together.

**Elenco® Electronics is not responsible for parts damaged due to incorrect wiring.**

**Note:** If you suspect you have damaged parts, you can follow the Advanced Troubleshooting procedure on page 9 to determine which ones need replacing.



**Warning to Snap Circuits® Owners:** Use only parts included in this kit to prevent damage.





























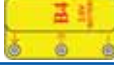



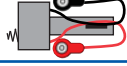



**WARNING:** If you have long hair, be careful that it does not get caught in the fan blade.



## Batteries:

- Do not short circuit the battery terminals.
- Never throw batteries in a fire or attempt to open it.
- Use only 1.5V AAA type (not included) in the FM radio.
- Insert batteries with correct polarity.
- Non-rechargeable batteries should not be recharged.
- Do not mix alkaline, standard (carbon-zinc), or rechargeable (nickel-cadmium) batteries.
- Do not mix old and new batteries.
- Remove batteries when they are used up.
- Batteries are harmful if swallowed, so keep away from small children.

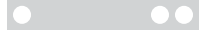
## Parts List (Colors and styles may vary) Symbols and Numbers

| Qty. | ID   | Name                            | Symbol  | Part # | Qty. | ID   | Name                     | Symbol  | Part # |
|------|------|---------------------------------|---|--------|------|------|--------------------------|---|--------|
| □ 1  |      | Base Grid<br>(11.0" x 7.7")     |    | 6SCBG  | □ 1  |      | Zinc Electrode with Snap |    | 6SCEZS |
| □ 2  | (1)  | 1-Snap Wire                     |    | 6SC01  | □ 1  | (HC) | Hand Crank               |    | 6SCHC  |
| □ 3  | (2)  | 2-Snap Wire                     |    | 6SC02  | □ 1  |      | Liquid Holder            |    | 6SCLH  |
| □ 3  | (3)  | 3-Snap Wire                     |    | 6SC03  | □ 1  | (M4) | Motor                    |    | 6SCM4  |
| □ 1  | (4)  | 4-Snap Wire                     |    | 6SC04  | □ 1  |      | Wind Fan                 |    | 6SCM4B |
| □ 1  | (5)  | 5-Snap Wire                     |    | 6SC05  | □ 1  |      | Water Wheel              |    | 6SCM4C |
| □ 1  |      | Jumper Wire (Black)             |    | 6SCJ1  | □ 1  | (M6) | Meter                    |    | 6SCM6  |
| □ 1  |      | Jumper Wire (Red)               |    | 6SCJ2  | □ 1  |      | Pivot Stand Base         |    | 6SCPSB |
| □ 1  | (B4) | Rechargeable Battery            |    | 6SCB4  | □ 1  |      | Pivot Post               |    | 6SCPSP |
| □ 1  | (B7) | Solar Cell                      |    | 6SCB7  | □ 1  |      | Pivot Top                |    | 6SCPST |
| □ 1  |      | Battery Eliminator for FM Radio |   | 6SCBE  | □ 1  |      | FM Radio                 |   | 6SCFM2 |
| □ 1  | (C5) | 470µF Capacitor                 |  | 6SCC5  | □ 1  | (S2) | Press Switch             |  | 6SCS2  |
| □ 1  | (D1) | Red LED                         |  | 6SCD1  | □ 1  | (S5) | Slide Switch             |  | 6SCS5  |
| □ 1  | (D5) | Yellow LED                      |  | 6SCD5  | □ 1  | (T2) | Clock                    |  | 6SCT2  |
| □ 3  |      | Copper Electrode                |  | 6SCEC  | □ 1  | (W1) | Horn                     |  | 6SCW1  |
| □ 1  |      | Copper Electrode with Snap      |  | 6SCECS | □ 3  |      | Screw 8-32 Phillips      |  | 641840 |
| □ 3  |      | Zinc Electrode                  |  | 6SCEZ  | □ 3  |      | Nut 8-32                 |  | 644800 |

You may order additional / replacement parts at our website: [www.snapcircuits.net](http://www.snapcircuits.net)

# How to Use It

Snap Circuits® uses building blocks with snaps to build the different electrical and electronic circuits in the projects. Each block has a function: there are switch blocks, light blocks, battery blocks, different length wire blocks, etc. These blocks are different colors and have numbers on them so that you can easily identify them. The circuit you will build is shown in color and numbers, identifying the blocks that you will use and snap together to form a circuit.

## For Example:

This is the switch block which is green and has the marking  $S_2$  on it. The part symbols in this booklet may not exactly match the appearance of the actual parts, but will clearly identify them.



This is a wire block which is blue and comes in different wire lengths. This one has the number 2, 3, 4, or 5 on it depending on the length of the wire connection required.



There is also a 1-snap wire that is used as a spacer or for interconnection between different layers.



A large clear plastic base grid is included with this kit to help keep the circuit blocks properly spaced. You will see evenly spaced posts that the different blocks snap into. The base has rows labeled A-G and columns labeled 1-10.

Next to each part in every circuit drawing is a small number in black. This tells you which level the component is placed at. Place all parts on level 1 first, then all of the parts on level 2, then all of the parts on level 3, etc.

Some circuits use the jumper wires to make unusual connections. Just clip them to the metal snaps or as indicated.



**Note:** While building the projects, be careful not to accidentally make a direct connection across the battery holder (a "short circuit"), as this may damage and/or quickly drain the batteries.

To use the radio, connect the earphone and battery eliminator to it as shown. Connect the wires from the battery eliminator to a circuit as shown in the projects.

Connect earphone



1

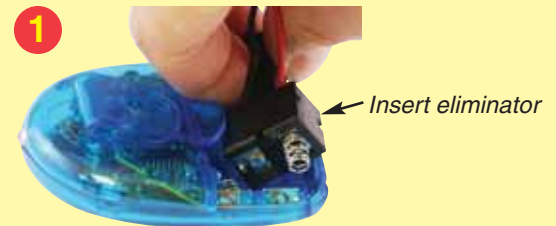

2

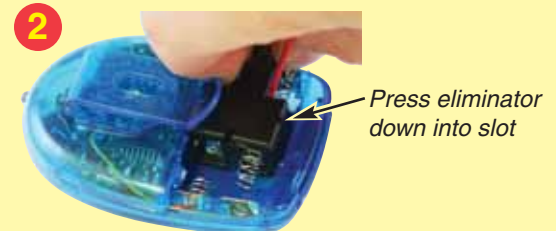

3

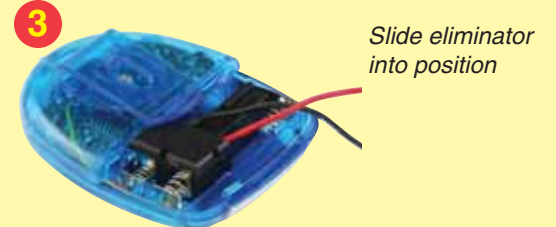

Alternately, the radio may be operated independently of this product using two "AAA" batteries (not included). Be sure to install batteries with the (+) and (-) terminals as shown in the battery compartment.

# How to Use It

**The 3.6V rechargeable battery (B4) may have discharged during shipping and distribution. Recharge it as shown in project 3 and others.**

*Sometimes parts will be mounted on a pivot, so they can be adjusted for the best angle to the wind or sun. Assemble the pivot as shown here:*

*Insert post into pivot top, snapping into place.*

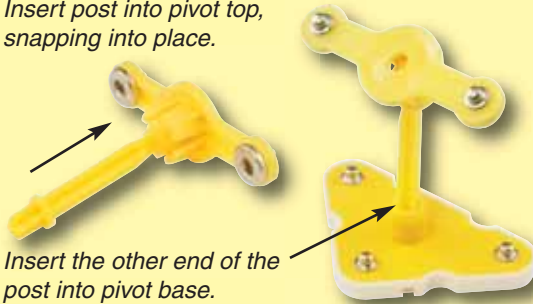

*Insert the other end of the post into pivot base.*

*Whenever the motor (M4) is used, it will have the wind fan or the water wheel placed on top; simply push the fan onto the shaft. To remove it, push up on it with a screwdriver or your thumbs, being careful not to break it.*

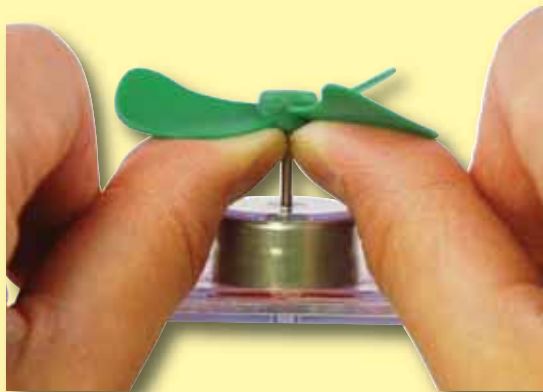

## Assembling the Liquid Power Source:

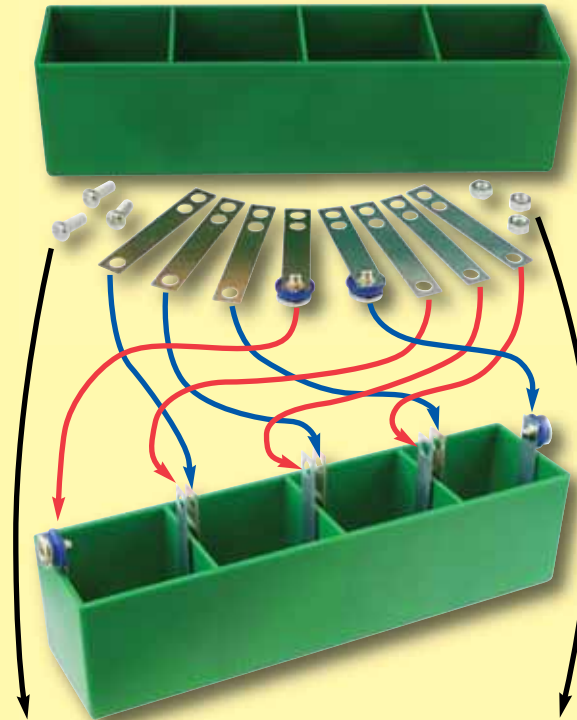

*Connect the 3 electrode parts together with screws and nuts as shown. Tighten by hand, a screwdriver is not needed.*



*If the copper and zinc electrodes get corroded through use, use sandpaper, steel wool, or a scraper to remove the corrosion and improve performance.*

## Setting the time on the clock (T2):

- Press the left button to select what to change (month, date, hour, or minutes).
- Press the right button until it is correct.
- Press the left button until the time is showing, then press the right button once to start.
- The colon (":") will be flashing when the clock is running.
- Press the right button to display the date.



# About Your Snap Circuits® Green Parts

(Part designs are subject to change without notice).

## BASE GRID

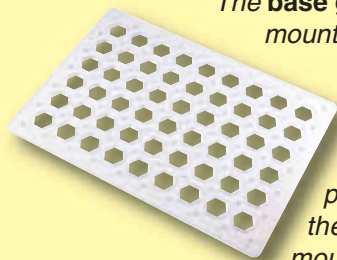

The **base grid** is a platform for mounting parts and wires. It functions like the printed circuit boards used in most electronic products, or like how the walls are used for mounting the electrical wiring in your home.

## SNAP WIRES & JUMPER WIRES

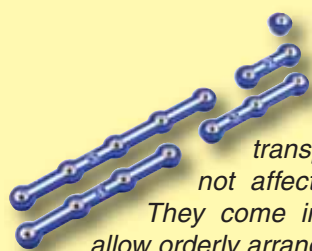

The blue **snap wires** are wires used to connect components. They are used to transport electricity and do not affect circuit performance. They come in different lengths to allow orderly arrangement of connections on the base grid.

The red and black **jumper wires** make flexible connections for times when using the snap wires would be difficult. They also are used to make connections off the base grid (like the projects using water).



Wires transport electricity just like pipes are used to transport water. The colorful plastic coating protects them and prevents electricity from getting in or out.

## BATTERY

The **battery (B4)** contains a rechargeable battery and some supporting parts. This battery produces an electrical **voltage** using a reversible chemical reaction. This “voltage” can be thought of as electrical pressure, pushing electricity through a circuit just like a pump pushes water through pipes. This voltage is much lower and much safer than that used in your house wiring. Using more batteries increases the “pressure” and so more electricity flows.



Battery (B4)

## SOLAR CELL

The **solar cell (B7)** contains positively and negatively charged silicon crystals, arranged in layers that cancel each other out. When sunlight shines on it, charged particles in the light unbalance the silicon layers and produce an electrical voltage of up to 7V. The maximum current depends on the type of light and its brightness, but will be much less than a battery can produce. Bright sunlight works best, but incandescent light bulbs also work.



Solar Cell (B7)

## LIQUID HOLDER & ELECTRODES

Liquid Holder

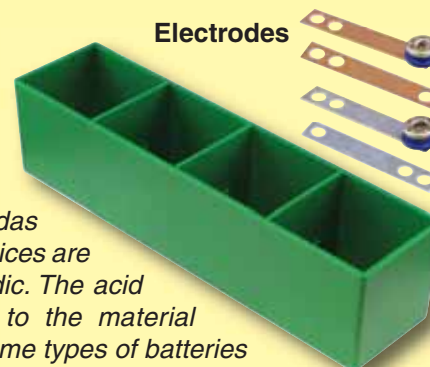

Most sodas and fruit juices are lightly acidic. The acid is similar to the material used in some types of batteries but not nearly as strong. The acid will react with the copper and zinc electrodes to make an electric current, like a battery. Each of the four compartments in the liquid holder produces about 0.7V, but the current is very low and may not last long.

## RADIO & BATTERY ELIMINATOR



Radio & Battery Eliminator

Radio uses electromagnetic waves to send information through the air. Snap Circuits® includes a standard FM radio, and a battery eliminator to use with it. The radio can also be used with two 1.5V “AAA” type batteries (not included). The battery eliminator has circuitry to protect the radio from the higher voltages, which you can produce with this kit, since these could damage the radio.

# About Your Snap Circuits® Green Parts

## METER

The **meter (M6)** is an important measuring device. You will use it to measure the voltage (electrical pressure) and **current** (how fast electricity is flowing) in a circuit.



Meter (M6)

The meter measures voltage when connected in parallel to a circuit and measures the current when connected in series in a circuit.

This meter has one voltage scale (5V) and two current scales (0.5mA and 50mA). These use the same meter but with internal components that scale the measurement into the desired range. Sometimes resistors in the pivot stand will be used to change the 5V scale to 10V, or the 0.5mA scale to 5mA.



Meter Symbol

Inside the meter there is a fixed magnet and a moveable coil around it. As current flows through the coil, it creates a magnetic field. The interaction of the two magnetic fields causes the coil (connected to the pointer) to move (deflect).

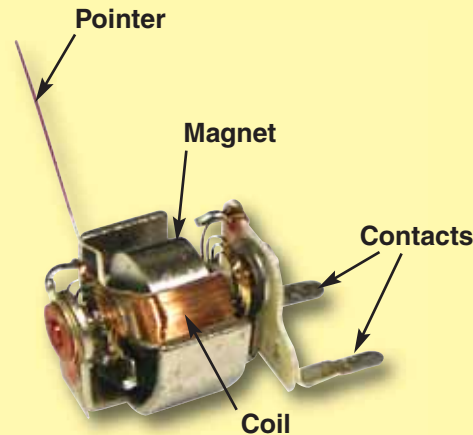

## MOTOR

The **motor (M4)** converts electricity into mechanical motion. An electric current through the motor will turn the shaft.

It can also be used as a generator, since it produces an electric current when the shaft is turned.

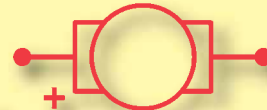

Motor Symbol

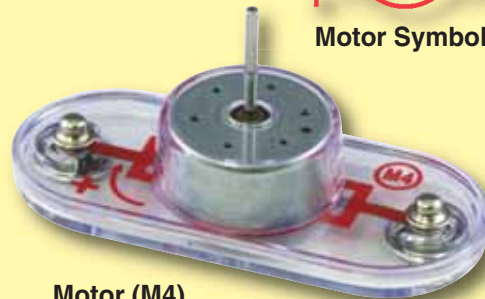

Motor (M4)

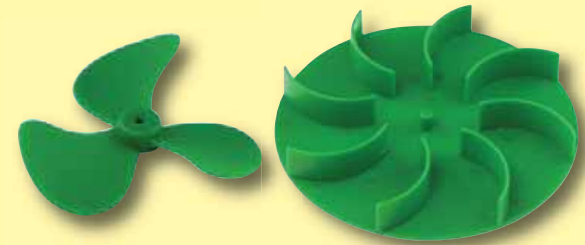

Fan

Water Wheel

How does electricity turn the shaft in the motor? The answer is magnetism. Electricity is closely related to magnetism, and an electric current flowing in a wire has a magnetic field similar to that of a very, very tiny magnet. Inside the motor is a coil of wire with many loops. If a large electric current flows through the loops, the magnetic effects become concentrated enough to move the coil. The motor has a magnet inside, so as the electricity moves the coil to align it with the permanent magnet, the shaft spins.

When used as a generator, wind or water turns the shaft. A coil of wire is on the shaft, and as it spins past the permanent magnet an electric current is created in the wire.

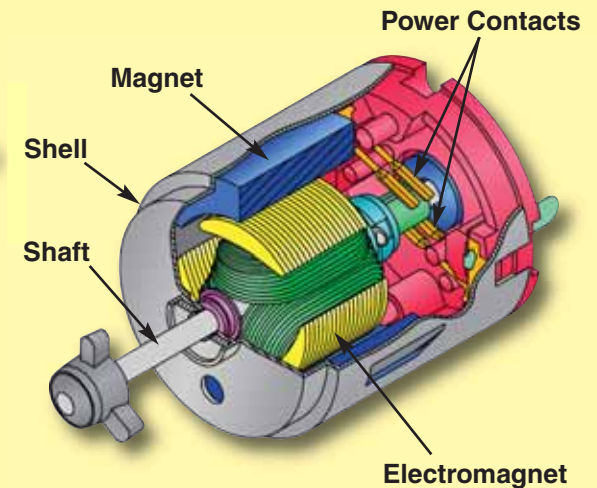

# About Your Snap Circuits® Green Parts

## HAND CRANK

The **hand crank (HC)** is a motor with a gearbox attached. The gearbox spins the motor shaft faster but with less force than you are turning the hand crank.

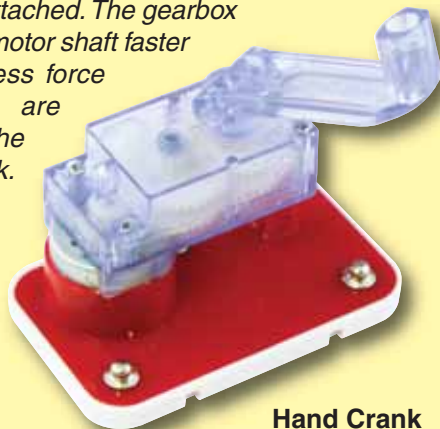

Hand Crank

## RED & YELLOW LEDs

The **red & yellow LED's (D1 & D5)** are light emitting diodes, and may be thought of as a special one-way light bulb. In the "forward" direction, (indicated by the "arrow" in the symbol) electricity flows if the voltage exceeds a turn-on threshold (about 1.5V for red and 2V for yellow); brightness then increases. A high current will burn out the LED, so the current must be limited by other components in the circuit. LED's block electricity in the "reverse" direction.



LED's (D1) & (D5)

## OTHER PARTS

The **horn (W1)** converts electricity into sound by making mechanical vibrations. These vibrations create variations in air pressure, which travel across the room. You "hear" sound when your ears feel these air pressure variations.



Horn (W1)

The **clock (T2)** contains a small crystal. When a crystal is struck by an electronic pulse, it vibrates. A microelectronic circuit makes the pulse and measures the vibration rate. The vibration rate is used as a time standard, from which minutes, hours, and the date are calculated.



Clock (T2)

## PRESS SWITCH

The **press switch (S2)** connects (pressed, "ON") or disconnects (not pressed, "OFF") the wires in a circuit. When ON it has no effect on circuit performance. It turns on electricity just like a faucet turns on water from a pipe.



Press Switch (S2)

## SLIDE SWITCH

**Slide Switch (S5)**



The **slide switch (S5)** connects (ON) the center snap to one of the other two snaps.

When connected it has no effect on circuit performance. It directs electricity just like a valve controls water in a pipe.

## CAPACITOR

The **470µF capacitor (C5)** can store electrical pressure (voltage) for periods of time. This storage ability allows it to block stable voltage signals and pass changing ones. Capacitors are used for filtering and delay circuits.



Capacitor (C5)

The **pivot stand** contains two resistors, 47Ω and 10KΩ. **Resistors** "resist" the flow of electricity and are used to control or limit the electricity in a circuit. Materials like metal have very low resistance (<1Ω), while materials like paper, plastic, and air have near-infinite resistance.

Increasing circuit resistance reduces the flow of electricity.



Pivot Stand



# DO's and DON'Ts of Building Circuits

After building the circuits given in this booklet, you may wish to experiment on your own. Use the projects in this booklet as a guide, as many important design concepts are introduced throughout them. Every circuit will include a power source (the batteries), a resistance (which might be a lamp, motor, electromagnet, etc.), and wiring paths between them and back. *You must be careful not to create "short circuits" (very low-resistance paths across the batteries, see examples below) as this will damage components and/or quickly drain your batteries.* Elenco® Electronics is not responsible for parts damaged due to incorrect wiring.

## Here are some important guidelines:

- ALWAYS** use eye protection when experimenting on your own.
- ALWAYS** include at least one component that will limit the current through a circuit, such as an LED, clock, or horn.
- ALWAYS** use the switches in conjunction with other components that will limit the current through them. Failure to do so will create a short circuit and/or damage those parts.
- ALWAYS** disconnect your batteries immediately and check your wiring if something appears to be getting hot.
- ALWAYS** check your wiring before turning on a circuit.
- NEVER** connect to an electrical outlet in your home in any way.
- NEVER** touch the motor when it is spinning at high speed.

For all of the projects given in this book, the parts may be arranged in different ways without changing the circuit. For example, the order of parts connected in series or in parallel does not matter — what matters is how combinations of these sub-circuits are arranged together.

**Warning to Snap Circuits® owners:** Use only parts included in this kit to prevent damage. Our website [www.snapcircuits.net](http://www.snapcircuits.net) has approved circuits that you can use.

## Examples of SHORT CIRCUITS - NEVER DO THESE!!!

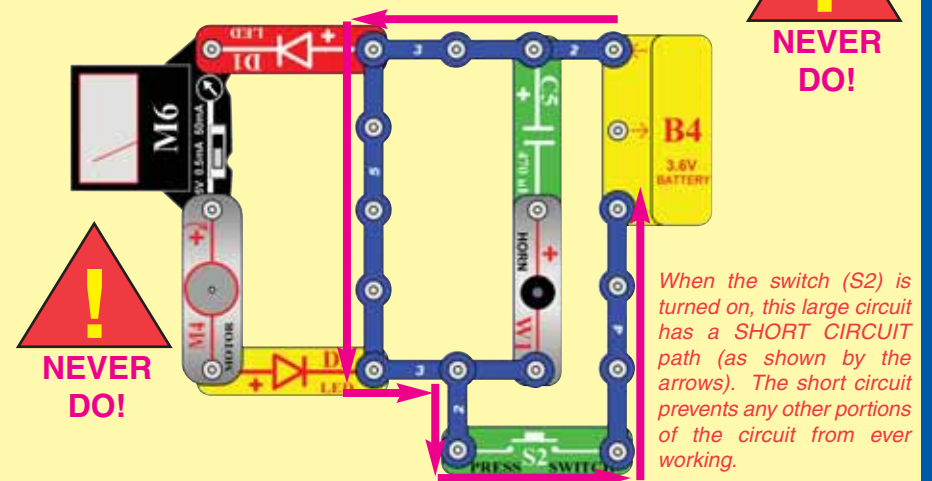
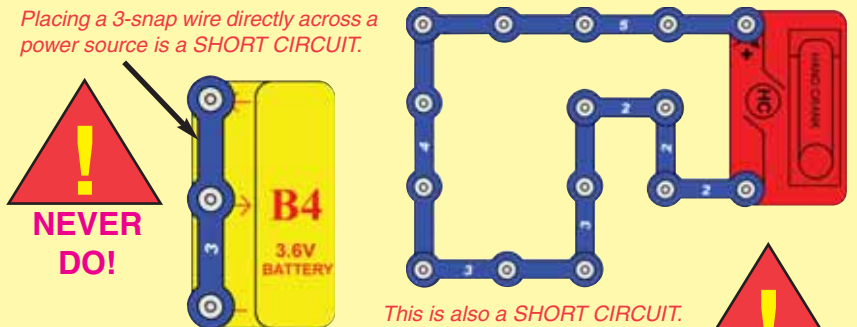

You are encouraged to tell us about new circuits you create. If they are unique, we will post them with your name and state on our website at [www.snapcircuits.net/kidkcreations.htm](http://www.snapcircuits.net/kidkcreations.htm). Send your suggestions to Elenco® Electronics: [elenco@elenco.com](mailto:elenco@elenco.com).

Elenco® provides a circuit designer so that you can make your own Snap Circuits® drawings. This Microsoft® Word document can be downloaded from [www.snapcircuits.net/SnapDesigner.doc](http://www.snapcircuits.net/SnapDesigner.doc) or through the [www.snapcircuits.net](http://www.snapcircuits.net) web site.

**WARNING: SHOCK HAZARD** - Never connect your Snap Circuits® set to the electrical outlets in your home in any way!

# Advanced Troubleshooting (Adult supervision recommended)

**Elenco® Electronics is not responsible for parts damaged due to incorrect wiring.**

If you suspect you have damaged parts, you can follow this procedure to systematically determine which ones need replacing:

1. **Hand crank (HC), solar cell (B7), and meter (M6):** Place the meter directly across the solar cell and set it to the 5V setting. Place the solar cell in sunlight or near a bright light source (incandescent light bulbs are best); the meter pointer should move. Then place the meter directly across the hand crank and turn the crank handle clockwise; the meter pointer should move for all the meter switch settings (5V, 0.5mA, and 50mA).

- If the 5V meter setting works with the hand crank but not the solar cell, then the solar cell is damaged. Be sure you used a bright light source and removed any protective plastic wrap covering the solar cell.
- If the 5V meter setting works with the solar cell but not the hand crank, then the hand crank is damaged.
- If the 5V meter setting does not work with either the solar cell or the hand crank, then the meter is damaged.
- If the 5V meter setting works with the hand crank but the 0.5mA or 50mA meter settings do not, then the meter is damaged.

2. **Red & black jumper wires:** Set the meter to the 5V setting and use this circuit to test each jumper wire. Place the solar cell (B7) near the same light source you used in step 1. The jumper wire is damaged if the meter pointer does not move.

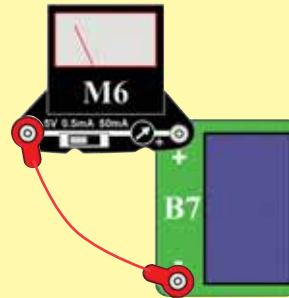

3. **Snap wires:** Set the meter to the 5V setting and use this circuit to test each snap wire, one at a time. Place the solar cell (B7) near the same light source you used in step 1. The snap wire is damaged if the meter pointer does not move.

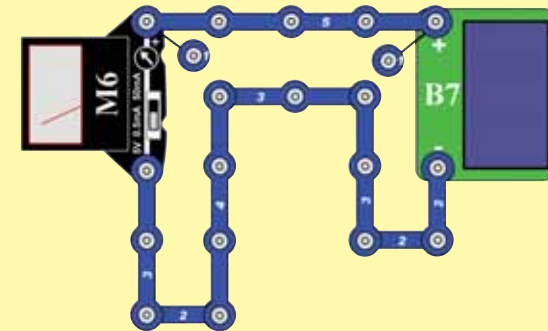
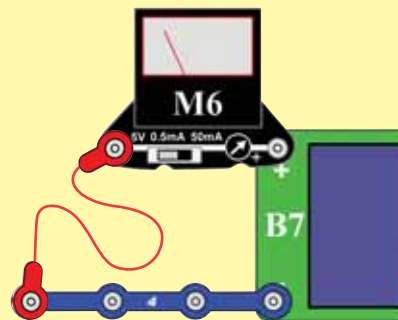

If you prefer, you can test all the snap wires at once using this circuit. If the meter pointer does not move, then test the snap wires one at a time to find the damaged one.

4. **Press switch (S2):** Set the meter to the 5V setting and build this circuit. Place the solar cell (B7) near the same light source you used in step 1. If the meter pointer does not move when you press the switch, the switch is damaged.

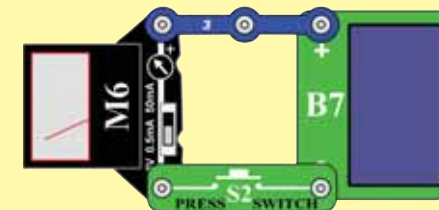

5. **Red and yellow LEDs (D1 & D5):** Place each LED directly across the hand crank (HC), without snapping it on. Make sure the "+" side of the LED matches the "+" side of the hand crank. Turn the crank handle clockwise; the LED will light unless it is damaged.

# Advanced Troubleshooting (continued)

6. **Battery (B4):** Build the circuit shown here and set the meter (M6) to the 5V setting.

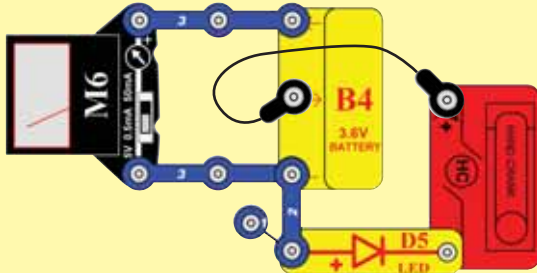

- The meter will measure more than 3V if the battery is charged up.
- If the meter pointer does not move from zero then either the battery is completely discharged or it is damaged.
- Turn the hand crank (HC) clockwise and check that the yellow LED (D5) comes on when you crank fast (indicating that the crank is charging the battery).
- If the meter was measuring zero then turn the crank for at least 20 seconds with the yellow LED on to see if it can be recharged.
- If the battery cannot be recharged, then it is damaged.
- If the battery needs to be recharged, you can use this circuit or see project 3 for other charging circuits.

7. **Slide switch (S5):** Slide switch (S5): Build this circuit and turn the hand crank (HC) clockwise until an LED lights. The red LED (D1) should light when the switch is in position B, and the yellow LED should light when the switch is in position C; otherwise the slide switch is damaged.

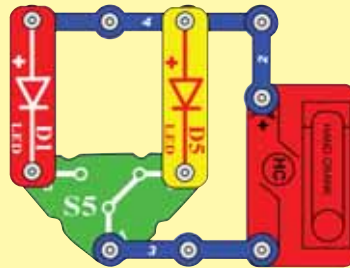

8. **Clock (T2), 470 $\mu$ F capacitor (C5), horn (W1), and motor (M4):** Build the circuit shown below, but remove the 470 $\mu$ F capacitor. Turn the hand crank (HC) clockwise and the clock display should turn on.

Add the 470 $\mu$ F capacitor back in; the clock display should stay on for a while after you stop turning the crank; otherwise the capacitor is damaged.

- Replace the clock with the horn. Turning the crank should sound the horn.
- Replace the horn with the motor (“+” on top, the fan doesn’t matter). Turning the crank clockwise should spin the motor shaft clockwise.

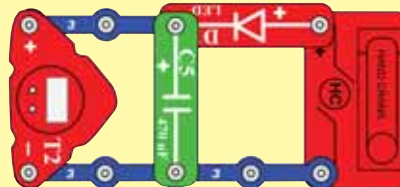

9. **Radio and battery eliminator:** Build project 118. Turning the hand crank (HC) should operate the radio. The radio can be tested without the battery eliminator using two “AAA” type 1.5V batteries (not included).

10. **Pivot stand resistors:** The pivot stand base has resistors mounted inside; they can be tested using this circuit. Turn the hand crank (HC) clockwise to light the LEDs. If the slide switch (S5) is in position B then the yellow LED (D5) will be bright. If the slide switch is in position C, the red LED (D1) will be dim. If either LED does not light or the red one is brighter than the yellow then the pivot stand is damaged.

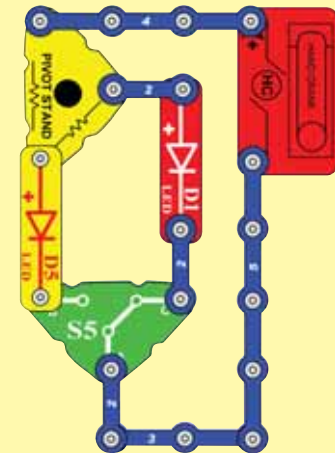

11. Check the remaining parts by inspecting them for damage.

## Elenco® Electronics, Inc.

150 Carpenter Avenue  
 Wheeling, IL 60090 U.S.A.  
 Phone: (847) 541-3800  
 Fax: (847) 520-0085  
 e-mail: [help@elenco.com](mailto:help@elenco.com)  
 Website: [www.elenco.com](http://www.elenco.com)

You may order additional /  
 replacement parts at:  
[www.snapcircuits.net](http://www.snapcircuits.net)

## Project Listings

| Project # | Description            | Page # | Project # | Description          | Page # | Project # | Description            | Page # |
|-----------|------------------------|--------|-----------|----------------------|--------|-----------|------------------------|--------|
| 1         | Crank Charger          | 13     | 24        | Water Wheel          | 25     | 46        | Splitting Different    |        |
| 2         | Hand Cranking          | 13     | 25        | Motor Voltage        | 25     |           | Currents               | 34     |
| 3         | Best Charging Circuits | 14     | 26        | Crank Motor          | 26     | 47        | Voltage Order          | 35     |
| 4         | Solar Power            | 15     | 27        | Crank Motor Voltage  | 26     | 48        | Current Order          | 36     |
| 5         | Solar Motor            | 15     | 28        | Radio Current        | 27     | 49        | Sources in Series      | 37     |
| 6         | Solar Charger          | 16     | 29        | Long Light           | 28     | 50        | Sources in Parallel    | 37     |
| 7         | Solar Charger 5mA      | 16     | 30        | LED Currents         | 28     | 51        | Two in Series          | 38     |
| 8         | Windmill               | 17     | 31        | Battery Load         | 29     | 52        | Two in Parallel        | 38     |
| 9         | Windy Lights           | 17     | 32        | Battery Load Current | 29     | 53        | Sound Starter          | 39     |
| 10        | Multi Power            | 18     | 33        | Make Your Own Parts  | 30     | 54        | Two Speed Motor        | 39     |
| 11        | Battery Power          | 18     | 34        | Liquid Resistors     | 30     | 55        | Big Blade Wind Horn    | 40     |
| 12        | Wind Warning           | 19     | 35        | Liquid Light         | 30     | 56        | Windy Time             | 40     |
| 13        | Light Charger          | 19     | 36        | Moving Voltage       | 31     | 57        | Wind Charger           |        |
| 14        | Electric Circuit       | 20     | 37        | Moving More Voltage  | 31     |           | with Light             | 41     |
| 15        | Close the Door         | 21     | 38        | Power Sources        | 32     | 58        | Wind Charger           |        |
| 16        | Feeling Switchy        | 21     | 39        | Powering Clock       | 33     |           | with Horn              | 41     |
| 17        | Voltage & Current      | 22     | 40        | Powering Horn        | 33     | 59        | Kick Start Motor       | 41     |
| 18        | Light Emitting Diode   | 22     | 41        | Powering LED         | 33     | 60        | Short Wind Power       | 42     |
| 19        | Resistors              | 23     | 42        | Powering Big Voltage | 33     | 61        | Wind Horn              | 42     |
| 20        | Honk Your Horn         | 23     | 43        | Powering Big Current | 33     | 62        | Liquid Battery         | 43     |
| 21        | Clock                  | 24     | 44        | Splitting Current    | 34     | 63        | Juice Battery          | 43     |
| 22        | Capacitor              | 24     | 45        | Splitting Current    |        | 64        | Cola Light             | 44     |
| 23        | Motor                  | 25     |           | Differently          | 34     | 65        | Yellow Cola            | 44     |
|           |                        |        |           |                      |        | 66        | Electricity From Water | 45     |

## Project Listings

| Project # | Description                                     | Page # | Project # | Description                    | Page # | Project # | Description              | Page # |
|-----------|---|--------|-----------|--------------------------------|--------|-----------|--------------------------|--------|
| 67        | Water Light                                     | 45     | 86        | Crank Sound                    | 55     | 107       | Capacitor Charging       | 66     |
| 68        | Cola Clock                                      | 46     | 87        | Hand Lights                    | 56     | 108       | Stopped Motor Alarm      | 66     |
| 69        | Cola Clock with Memory                          | 46     | 88        | Hand Noise                     | 56     | 109       | Saving Energy            | 67     |
| 70        | Changing Water Pressure to Electrical Pressure  | 47     | 89        | Heavy Fan                      | 57     | 110       | Energy Transmission Loss | 67     |
| 71        | FM Radio  | 47     | 90        | Remote Heater                  | 57     | 111       | Regulating Power         | 68     |
| 72        | Hydro Lights                                    | 48     | 91        | Remote Water Heater            | 58     | 112       | Sun & Wind Light         | 68     |
| 73        | Directional Wind Lights                         | 48     | 92        | Electrical Material Checker    | 58     | 113       | Hybrid                   | 69     |
| 74        | Using Stored Water                              | 49     | 93        | Morse Code                     | 59     | 114       | Hybrid Car Concept       | 69     |
| 75        | Water Redirection                               | 49     | 94        | Morse Light                    | 59     | 115       | LED or Bulb?             | 70     |
| 76        | One of the Most Powerful Forces in the Universe | 50     | 95        | Everything Circuit             | 60     | 116       | Water Timer              | 70     |
| 77        | Electricity Against Water                       | 50     | 96        | Light Signal for Radio         | 61     | 117       | Solar Fan                | 71     |
| 78        | Harnessing Static Electricity                   | 51     | 97        | Light & Sound Signal for Radio | 61     | 118       | Hand Radio               | 71     |
| 79        | Storing Energy in Water                         | 52     | 98        | Speed Indicator                | 62     | 119       | Hand Charger             | 72     |
| 80        | Big Thrust                                      | 52     | 99        | Sound Pulse                    | 62     | 120       | Parallel Cranking        | 72     |
| 81        | Solar Light Clock                               | 53     | 100       | Motor Speed LED                | 63     | 121       | Hard to Crank            | 73     |
| 82        | Solar Light Charger                             | 53     | 101       | Energy Converter               | 63     | 122       | Slow In Flash Out        | 73     |
| 83        | Solar Lights Row                                | 54     | 102       | Energy Conversion              | 64     | 123       | Filling Station          | 74     |
| 84        | Crank Support                                   | 54     | 103       | Small Energy Conversion        | 64     | 124       | Gas Pedal                | 74     |
| 85        | Crank Charging                                  | 55     | 104       | Mechanical Energy Conversion   | 64     | 125       | Volt Meter               | 75     |
|           |   |        | 105       | Triple Current Meter           | 65     | 126       | Anemometer               | 75     |
|           |   |        | 106       | Clock with Memory              | 65     | 127       | Current Meter            | 76     |
|           |   |        |           |                                |        | 128       | Wind Direction           | 76     |
|           |   |        |           |                                |        | 129       | Windy Radio              | 77     |



# Project #1

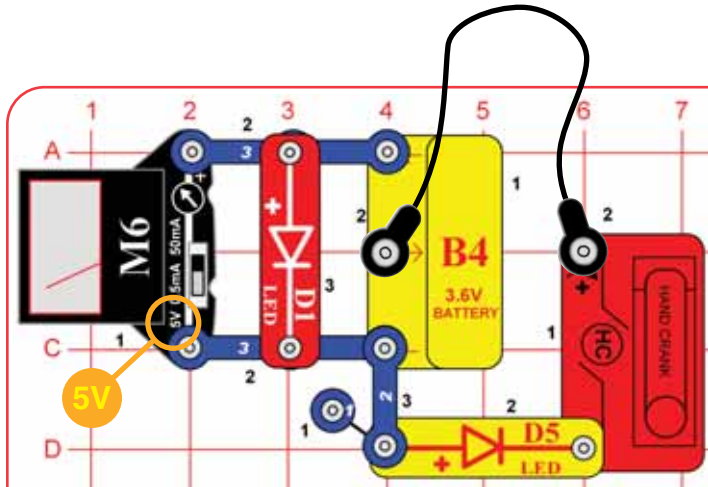

# Crank Charger

Although the battery is rated as 3.6V, it may charge to as high as 4.0V. If you are monitoring the voltage using the meter, you may see the voltage quickly reach 3.6V, but this does not mean that the battery is fully charged. When the battery is discharging to power something, the voltage is nearly steady for a long while then drops off quickly. The same thing occurs when it is charging. Recharging the battery will quickly reach around 3.6V but it needs much more charging to avoid a quick drop-off when discharging.

Build the circuit shown here and set the meter (M6) to the 5V setting. The meter will measure about 3.6V if the battery is charged up.

Turn the hand crank (HC) clockwise. The yellow LED (D5) comes on when you crank fast, indicating that the crank is charging the battery.

If the battery needs to be recharged, you can use this circuit to charge it.

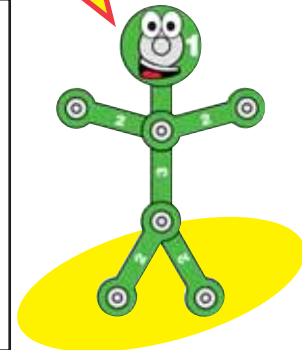

# Project #2

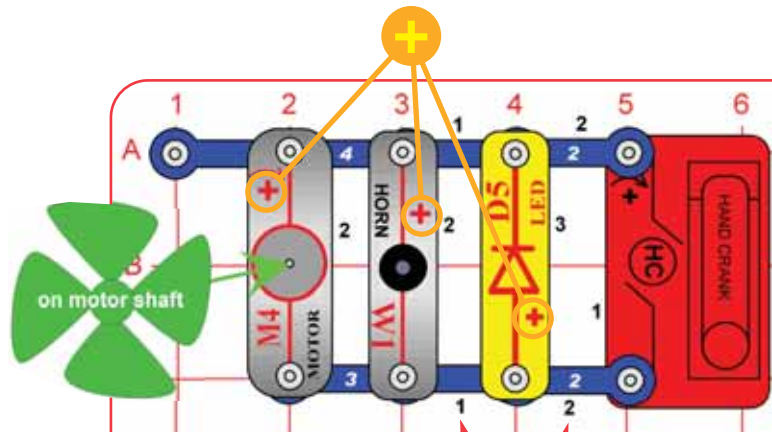

Placement Level Numbers

# Hand Cranking

Build the circuit shown by placing all the parts with a black 1 next to them on the clear plastic base grid first. Then, assemble parts marked with a 2, and finally the parts marked with a 3. Be sure to place the parts with their (+) side oriented as shown. Place the wind fan on the motor (M4) shaft. Turn the handle on the hand crank (HC) in both directions to make things happen.

**Warning:** the hand crank is sturdy but not indestructible. If you push hard on it or crank it really fast you may break it.

The hand crank uses magnetism to change the mechanical energy of the spinning shaft into electricity.

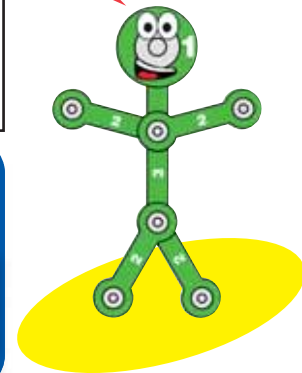



# Project #3

# Best Charging Circuits

Your rechargeable battery (B4) will need to be recharged often; use any of these circuits. Place the solar cell in sunlight or about 12 inches from an incandescent light bulb of 60W or more. It takes a few hours to charge the battery. Fluorescent lights do not work well with solar cells. You can't hurt the battery by overcharging.

**Circuit #1:** The solar cell is on the pivot so you can adjust it for best angle to your light source, and uses the meter (M6) to measure the voltage.

**Circuit #2:** The solar cell is on the pivot so you can adjust it for best angle to your light source.

**Circuit #3:** This uses only a few parts, so you can build many of the other circuits while charging the battery.

Although the battery is rated as 3.6V, it may charge to as high as 4.0V. If you are monitoring the voltage using the meter, you may see the voltage quickly reach 3.6V, but this does not mean that the battery is fully charged. When the battery is discharging to power something, the voltage is nearly steady for a long while then drops off quickly. The same thing occurs when it is charging. Recharging the battery will quickly reach around 3.6V but it needs much more charging to avoid a quick drop-off when discharging. Recharge the battery for several hours.

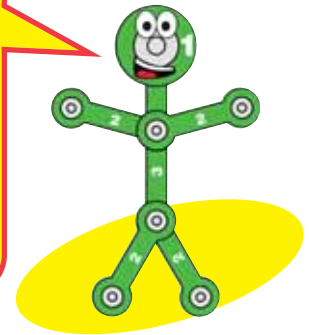

## 1 Best angle adjustment to light source with voltage measurement:

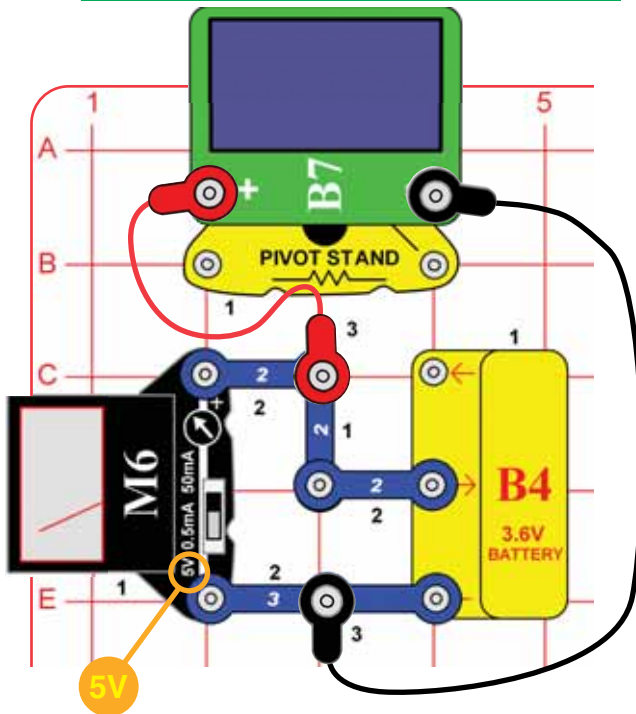

## 2 Best angle adjustment to light source:

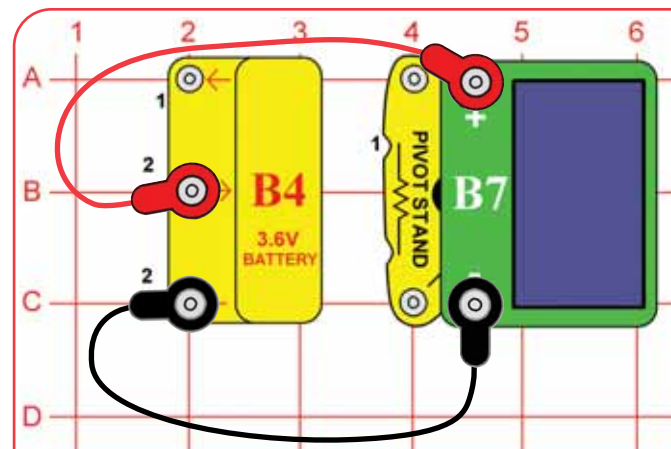

## 3 Minimum parts:

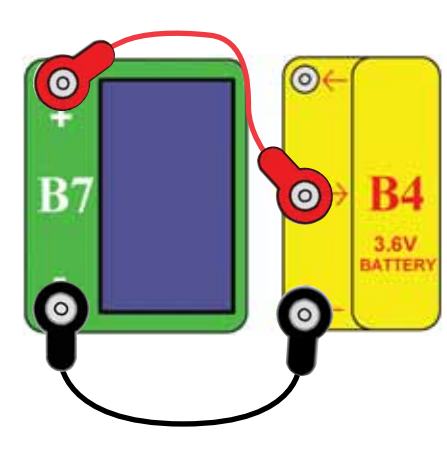

### ASSEMBLING PIVOT STAND

- Place base on flat level surface.
- Snap ball on pivot post into pivot top.
- Insert post into base.



# Project #4

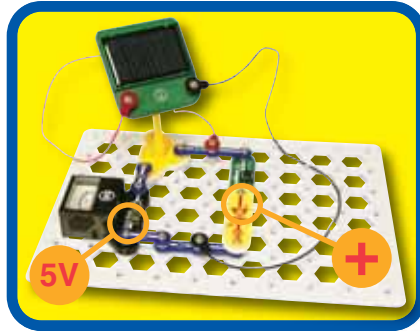
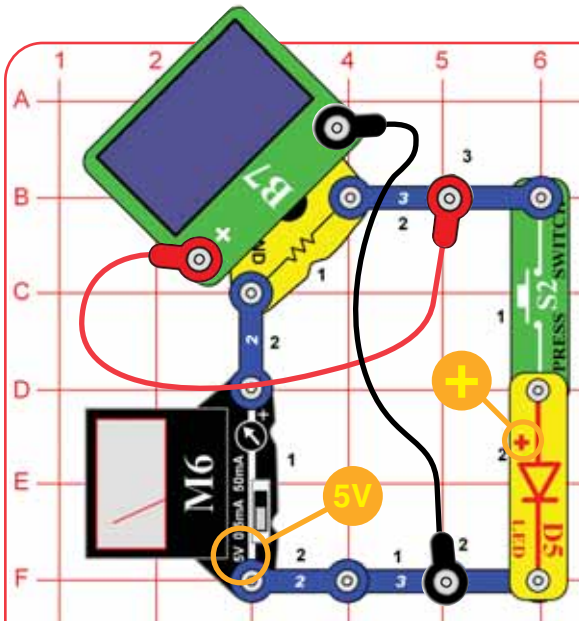

# Solar Power

Assemble the pivot, mount the solar cell (B7) on it, and place it in the circuit as shown. Place all the parts with a black 1 next to them on the clear plastic base grid first, then parts marked with a 2, and finally the parts marked with a 3.

Connect the solar cell to the circuit using the red and black jumper wires. Place the circuit so the solar cell is in bright sunlight or close to an incandescent light bulb. Set the meter (M6) to the 5V setting.

The meter is measuring the voltage produced by the solar cell. Adjust the position of the position of the solar cell on the pivot to see how the voltage produced changes depending on the angle to the light source and the brightness.

Position the solar cell to make the highest voltage you can. Now push the press switch to run the yellow LED (D5) with the solar cell. Notice how the voltage produced drops when the LED is connected.

**Note:** The voltage produced is actually twice that shown on the meter (so a 3V reading is really 6V), because a resistor in the pivot stand is changing the scale.

**Part B:** Replace the yellow LED with the red LED (D1) and press the switch. See how much it affects the solar cell voltage.

## ASSEMBLING PIVOT STAND

- 1 Place base on flat level surface.
- 2 Snap ball on pivot post into pivot top.
- 3 Insert post into base.

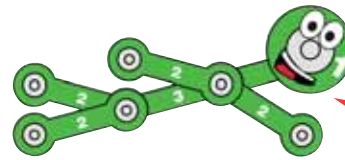

Your solar cell makes electricity from sunlight, but only a small amount. In bright sunlight it produces a voltage of about 7V, but this is reduced when lots of current is flowing. That is why the voltage drops when you connect the yellow LED.



# Project #5

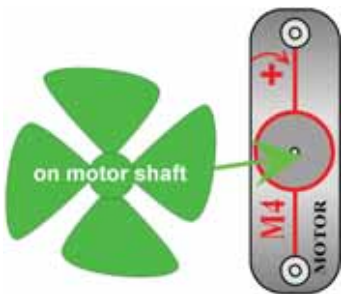

The motor needs less electricity from the solar cell as it speeds up, so the solar cell voltage is higher as the motor gets faster.

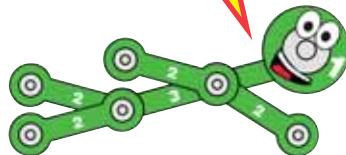

# Solar Motor

In the preceding circuit, replace the yellow LED (D5) with the motor (M4, in either direction) and place the wind fan on it. Now press the switch and watch how the voltage changes as the solar cell runs the fan. Depending on your light source, the fan may need a push to get started or may not work at all.





# Project #6

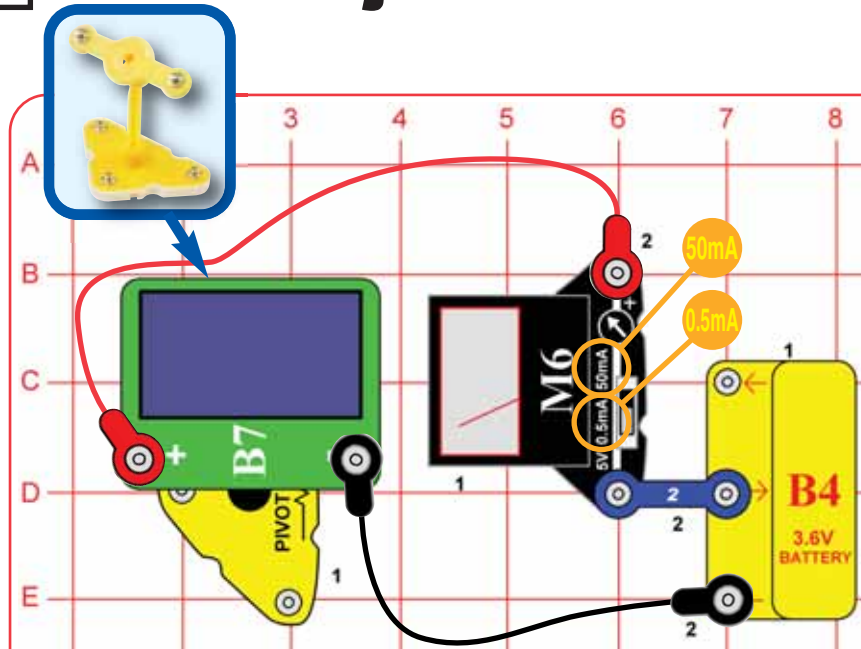

# Solar Charger

Assemble the pivot, mount the solar cell (B7) on it, and place it in the circuit as shown. Connect the solar cell to the circuit using the red and black jumper wires. Place the circuit so the solar cell is in bright sunlight or near an incandescent light bulb. Set the meter (M6) to the 0.5mA or 50mA setting.

The solar cell is charging the battery and the meter is measuring the current. The current depends on the type and brightness of your light source, and how much your battery needs recharging. Adjust the position of the solar cell to make the highest current; in bright sunlight it will be around 10mA.

When placed in sunlight or about 12 inches from a 60W incandescent light bulb, the solar cell will typically recharge the battery in a few hours. Current will flow into the battery even when it is fully charged. You can't hurt the battery by overcharging with the power sources in this kit.

Solar energy is free, abundant, and causes no pollution. However it is difficult to harvest it because even low power solar cells are expensive.

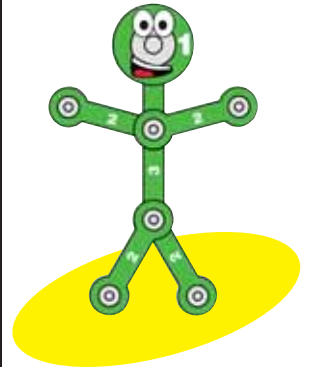

# Project #7

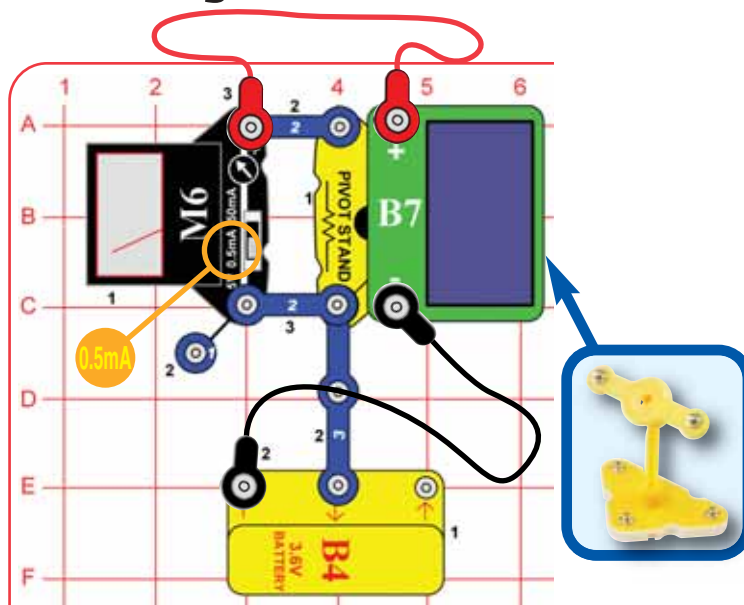

# Solar Charger 5mA

Modify the preceding circuit to match this one. Set the meter (M6) to the 0.5mA setting. Place the solar in sunlight or near an incandescent light bulb. The solar cell is charging the battery and the meter is measuring the current.

This circuit uses a resistor in the pivot stand to change the 0.5mA scale on the meter to a 5 mA scale, so read the current on the 0-5 scale. Charging current is usually in this range. Place your hand above the solar cell to see how easily the current changes, and try different light sources.

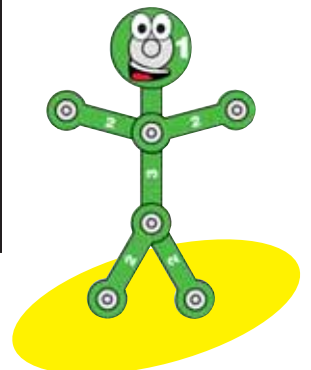



# Project #8

# Windmill

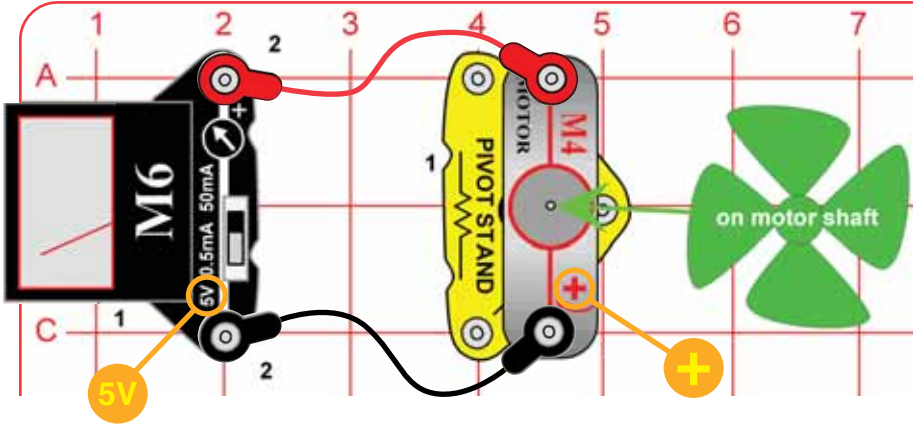

Assemble the pivot, mount the wind fan on the motor (M4), mount the motor on the pivot, place the pivot on the base grid and connect it to the meter (M6) using the red and black jumper wires. Set the meter to the 5V setting.

Blow on the fan or place it in a strong wind (either outside or near an electric fan). You may need to give the fan a push to get it started. The meter measures how much voltage your "windmill" produces. Adjust the pivot position to see how the voltage produced changes with the angle to the wind.

The windmill uses magnetism to change the mechanical energy of the spinning shaft into electricity. The voltage it produces is usually lower than the solar cell, but the current is higher.

### ASSEMBLING PIVOT STAND

- Place base on flat level surface.
- Snap ball on pivot post into pivot top.
- Insert post into base.

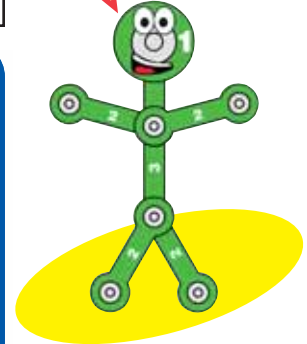
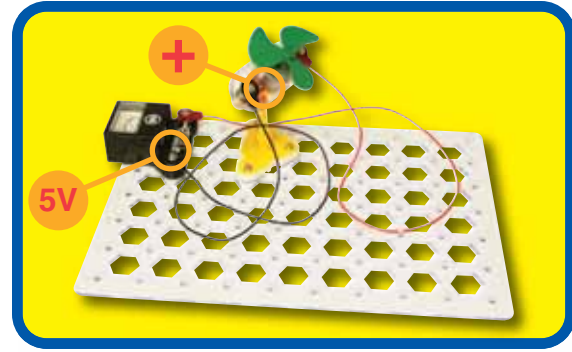

# Project #9

# Windy Lights

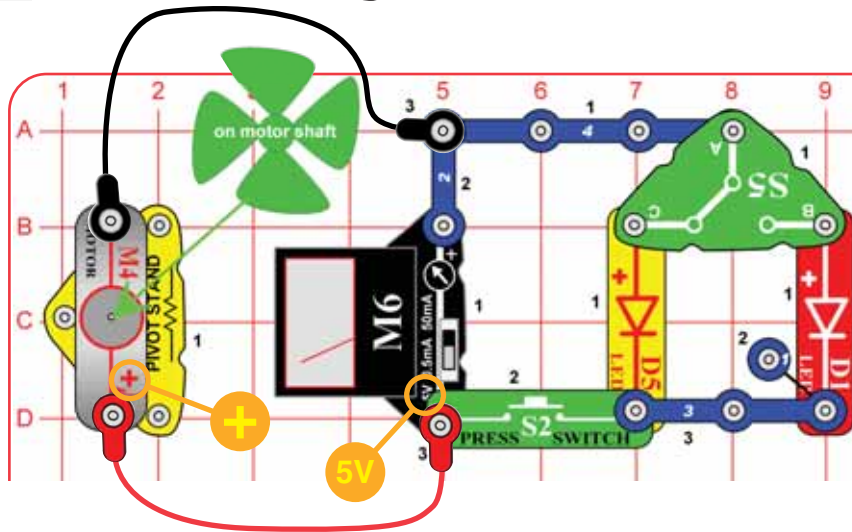

Build the circuit shown. Set the meter to the 5V setting. Blow on the fan or place it in a strong wind (either outside or near an electric fan). The meter measures how much voltage your "windmill" produces. You may need to give the fan a push to get it started.

Push the press switch (S2) to connect one of the LEDs (D1 & D5) to the windmill. The voltage produced drops a little, but not as much as for the solar cell circuits. Flip the slide switch (S5) to try the other LED. Compare the brightness of the LEDs at different wind speeds.

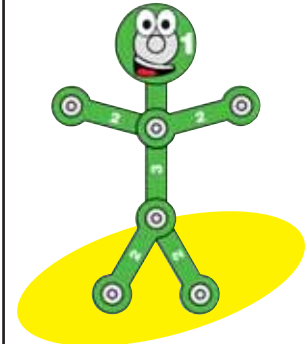



# Project #10

# Multi Power

The red and yellow LEDs (D1 & D5) are used here to keep the different power sources from interfering with each other, by controlling the direction electricity flows.

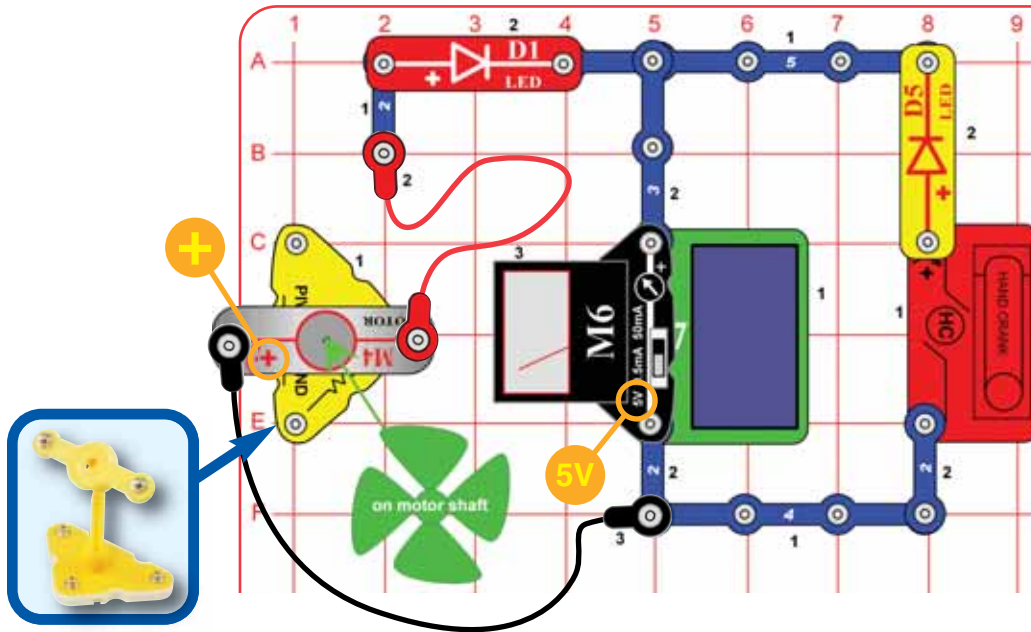
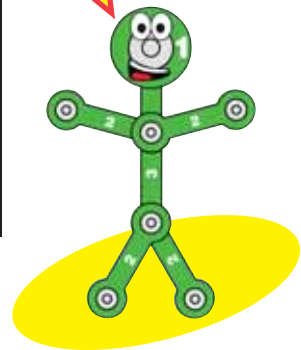

Build the circuit shown. Set the meter to the 5V setting. The meter measures the voltage produced by the windmill, solar cell, and hand crank, which are connected to work together.

You can change the meter setting to 50mA, to measure the current produced.



# Project #11

# Battery Power

The battery can store lots of energy, so it can run lots of things for a while. It is available whenever you need it, at the flip of a switch.

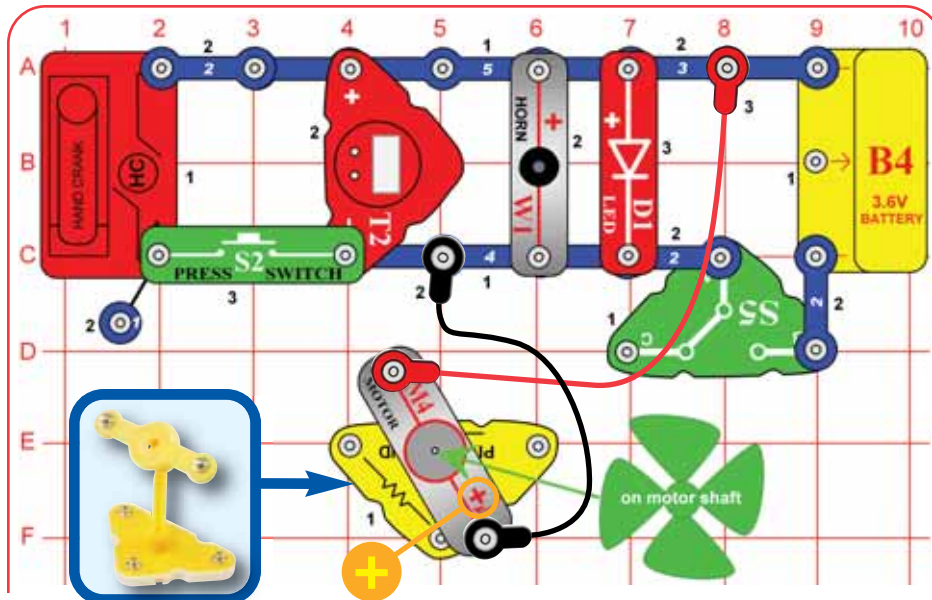
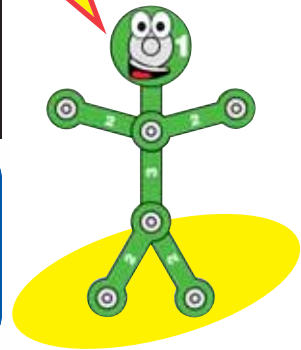

Make sure the battery is charged up (see projects 1-3). Build the circuit with the motor and fan on the pivot stand, and connect the jumper wires as shown. Set the slide switch (S5) to position B to turn on the circuit. The battery runs the clock display (T2), horn (W1), red LED (D1), and windmill (M4). Push the press switch (S2) and the hand crank (HC) will also spin.

**Part B:** Set the slide switch to position C to disconnect the battery, and blow on the fan or place it in a strong wind. See if your "windmill" will run things as well as the battery, and for how long.

**Part C:** Leave the slide switch at position C and push the press switch while turning the hand crank to see how well it runs things. Try cranking it in both directions.

See projects 1 & 3 if you need to recharge the battery (B4).





# Project #12

# Wind Warning

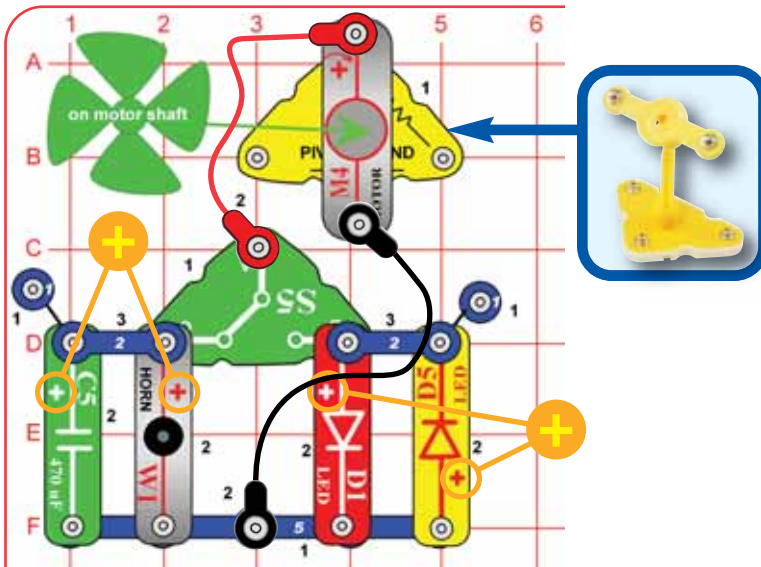

Build the circuit as shown, with the motor on the pivot. Blow on the fan or place it in a strong wind. Depending on the wind direction and the setting of the slide switch (S5), you may see lights or hear sound. You may need to give the fan a push to get it started.

This circuit can be used to warn you of dangerous winds.

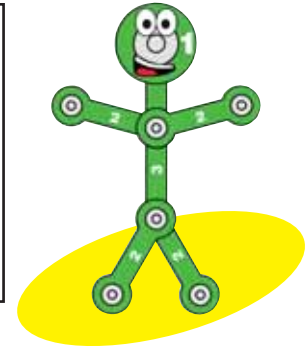

# Project #13

# Light Charger

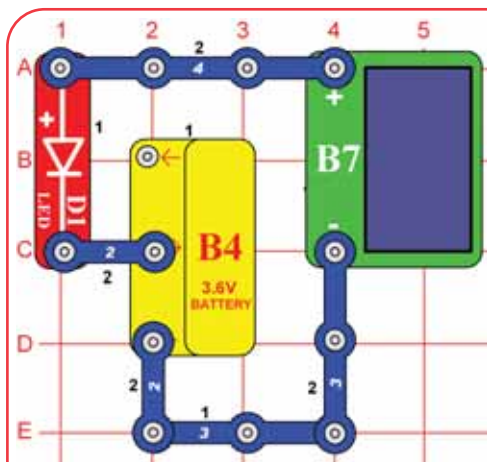

This circuit uses the solar cell (B7) to charge the rechargeable battery (B4). Place the solar cell in sunlight or near an incandescent light bulb. The red LED (D1) lights when the battery is being charged. The brighter the LED, the faster it is charging.

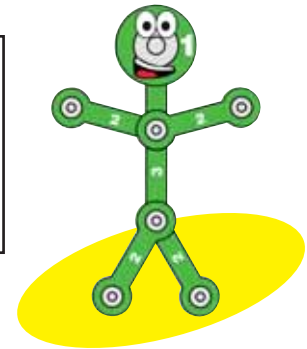



# Project #14

# Electric Circuit

Build the circuit shown and push the press switch (S2) to turn on red LED (D1).

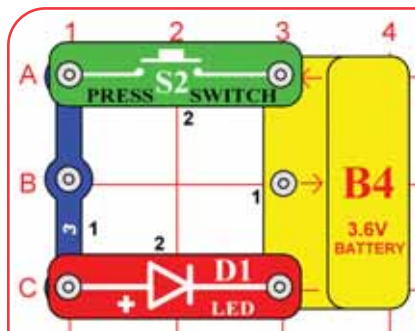

See projects 1 & 3 if you need to recharge the battery (B4).

## Educational Corner:

### What is really happening here?

1. The battery (B4, containing a 3.6V rechargeable battery with protection circuitry) converts chemical energy into electrical energy and "pushes" it through the circuit, just like the electricity from your power company. A battery pushes electricity through a circuit just like a pump pushes water through a pipe.
2. The snap wires (the blue pieces) carry the electricity around the circuit, just like wires carry electricity around your home. Wires carry electricity just like pipes carry water.
3. The press switch (S2) controls the electricity by turning it on or off, just like a light switch on the wall of your home. A switch controls electricity like a faucet controls water.
4. The red LED (D1, a "light emitting diode") converts electrical energy into light; it is similar to lights in your home. An LED shows how much electricity is flowing in a circuit like a water meter shows how fast water flows in a pipe.
5. The base grid is a platform for mounting the circuit, just like how wires are mounted in the walls of your home to control the lights.

### Comparing Electric Flow to Water Flow:

#### Electric Paths

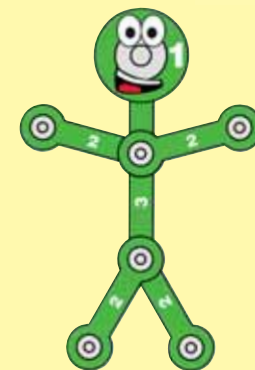
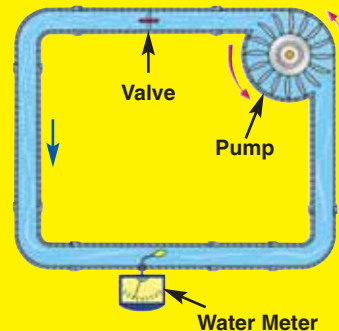
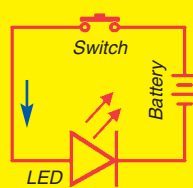



# Project #15

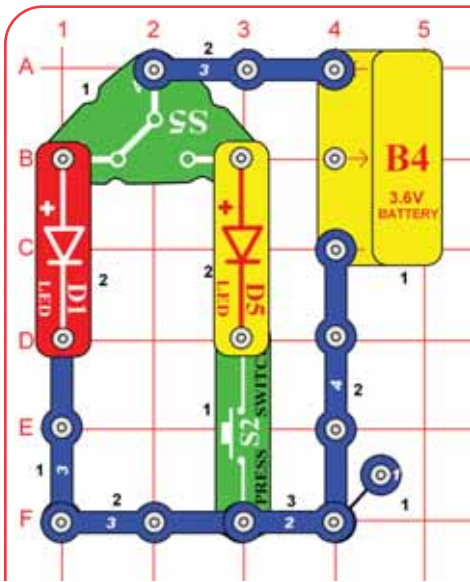

See projects 1 & 3 if you need to recharge the battery (B4).

Build the circuit shown. The slide and press switches (S5 & S2) control the lights.

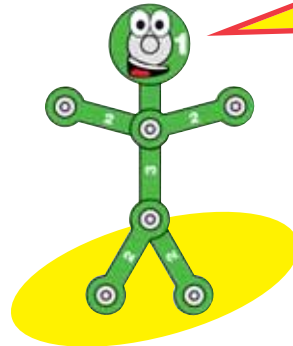

# Close the Door

The "on" position of a switch is also called the "closed" position. Similarly, the "off" position is also called the "open" position. This is because the symbol for a slide switch is similar to the symbol for a door in an architect's drawing of a room:

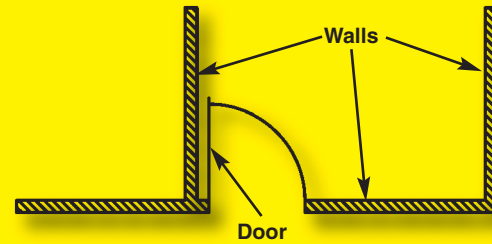

The electronics symbol for a slide switch should be thought of as a door to a circuit, which swings open when the switch is off. The "door" to the circuit is closed when the switch is on. This is shown here:

Your S5 switch has 2 positions, so it has a different symbol:

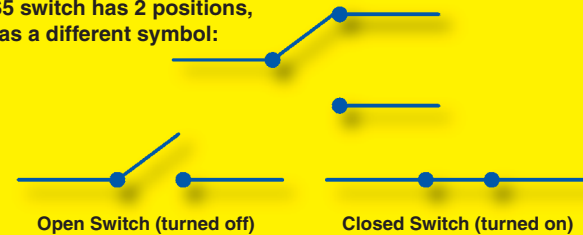

Open Switch (turned off)

Closed Switch (turned on)

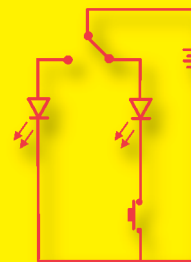

Left Switch Position Open (turned off)  
Right Switch Position Closed (turned on),  
right LED controlled by press switch

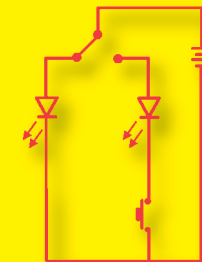

Left Switch Position Closed (turned on)  
Right Switch Position Open (turned off)



# Project #16

Build the circuit shown and push the press switch (S2) to turn on light or sound. Switches can be arranged in many different ways.

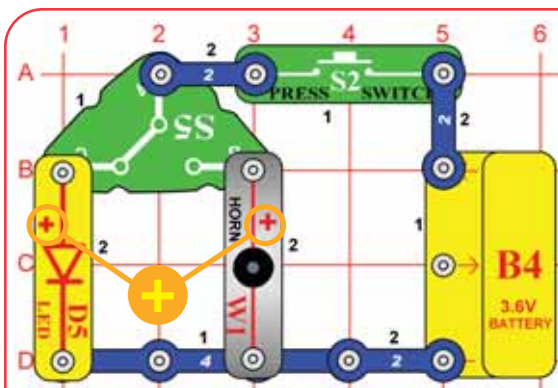

# Feeling Switchy

The press switch allows electricity to flow from the battery to the circuit, and the slide switch (S5) directs the electricity to either the yellow LED (D5) or the horn (W1). These switches are like many switches in your home, controlling lights and many other things.

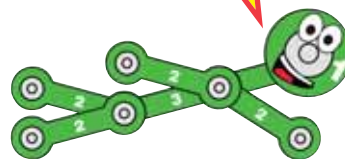



# Project #17

# Voltage & Current

See projects 1 & 3 if you need to recharge the battery (B4).

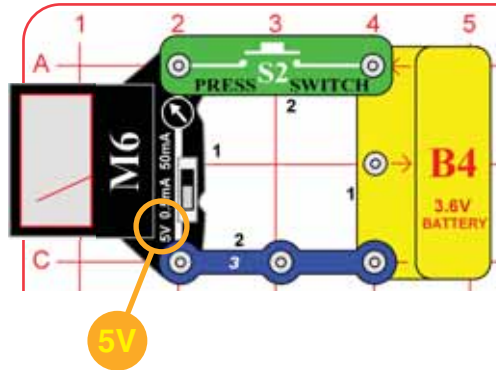

Build the circuit shown. Set the meter (M6) to the 5V setting. Push the switch (S2) to connect the meter to the battery and measure its voltage.

Electricity is the movement of sub-atomic charged particles (called **electrons**) through a material due to electrical pressure across the material, such as from a battery.

The electrical pressure exerted by a battery or other power source is called **voltage** and is measured in **volts** (V). Notice the “+” and “-” signs on the battery. These indicate which direction the battery will “pump” the electricity.

Circuits need the right voltage to work properly. For example, if the voltage to a light bulb is too low then the bulb won’t turn on; if too

high then the bulb will overheat and burn out.

The **electric current** is a measure of how fast electricity is flowing in a wire, just as the water current describes how fast water is flowing in a pipe. It is expressed in **amperes** (A) or **milliamps** (mA, 1/1000 of an ampere).

The “**power**” of electricity is a measure of how fast energy is moving through a wire. It is a combination of the voltage and current (Power = Voltage x Current). It is expressed in **watts** (W).

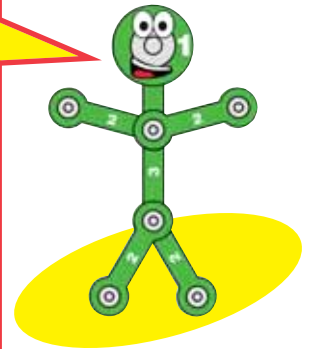

# Project #18

# Light Emitting Diode

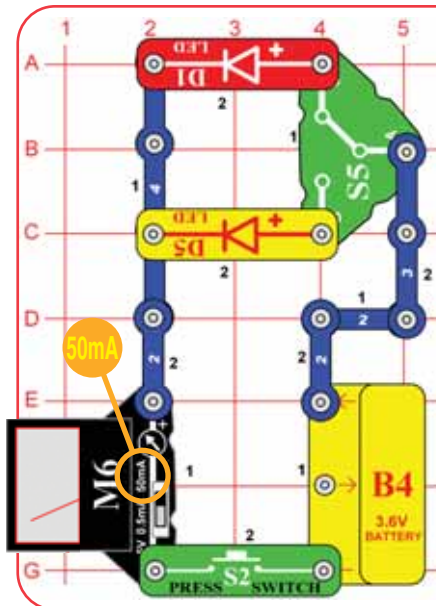

Build the circuit shown. Set the meter (M6) to the 50mA setting.

For each of the slide switch (S5) positions, push the press switch (S2) to measure the current through one of the LEDs (D1 & D5). Then change the slide switch (S5) to measure the current with the other LED, and compare them.

Now set the meter to the 5V setting, and compare the voltage measured with each LED. The voltage for both should be lower than what you measured directly at the battery in the preceding project, due to the voltage needed to turn on the LEDs.

Light emitting diodes (LEDs) are one-way lights with a turn-on voltage threshold. If the voltage is high enough, they will light. The yellow LED (D5) requires a higher voltage to turn it on, but can get brighter.

When electric current flows through an LED, energy is released as light; the color depends on the material. LEDs are much more energy efficient and last longer than ordinary light bulbs but were only used in low-power applications due to power limits, cost, and limited colors. However, LEDs are rapidly being improved and are increasingly being used in home lighting.

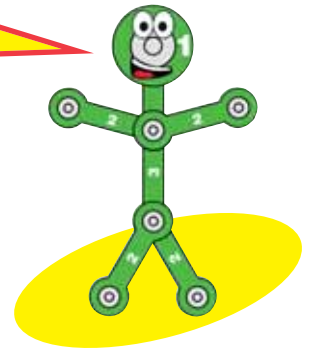



# Project #19

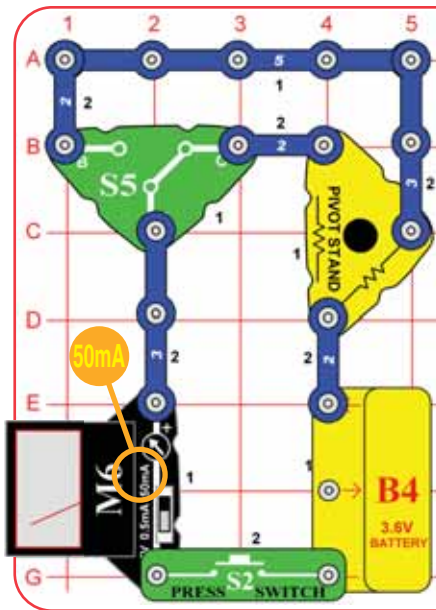

Build the circuit shown. Set the meter (M6) to the 50mA setting and the slide switch (S5) to position C. The pivot stand base has 47Ω and 10KΩ resistors in it. They are used to control the flow of electricity in a circuit.

Push the press switch (S2) to measure the current through the 47Ω resistor; it should be around 50mA.

To measure the current through the 10KΩ resistor, set the meter to the 0.5mA setting and the slide switch to position B. Push the press switch to show the current, it should be around 0.4mA. The current is much lower this time, because the 10KΩ is a higher value resistor.

The meter has internal resistors, which scale the measurement it makes into the ranges indicated on it. The 10KΩ resistor can be used with it to double the voltage scale to 10V. Keep the slide switch in position B, set the meter to the 5V setting, and push the press switch to measure the battery voltage using a 10V scale (double what you read on the 5V scale).

# Resistors

The **resistance** of a circuit represents how much it resists the electrical pressure (voltage) and limits the flow of electric current. The relationship is  $Voltage = Current \times Resistance$ . When there is more resistance, less current will flow unless you increase the voltage. Resistance is measured in ohms (Ω), or kilo ohms (KΩ, 1000 ohms).

**What is Resistance?** Take your hands and rub them together very fast. Your hands should feel warm. The friction between your hands converts your effort into heat. Resistance is the electrical friction between an electric current and the material it is flowing through; it is the loss of energy from electrons as they move through the material.

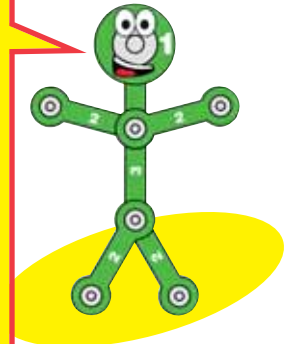

# Project #20

See projects 1 & 3 if you need to recharge the battery (B4).

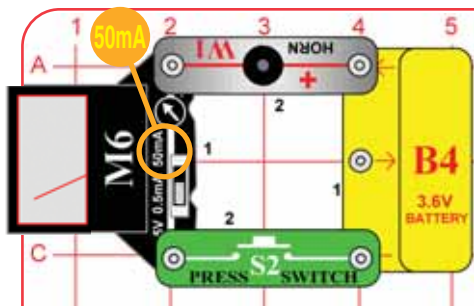

# Honk Your Horn

The horn converts electricity into sound energy by making mechanical vibrations. These vibrations create variations in air pressure, which travel across the room. You "hear" sound when your ears feel these air pressure variations.

Build the circuit, set the meter (M6) to the 50mA setting. Push the switch (S2) to "honk" the horn (W1), while the meter measures the current through it.

Compare the current with the horn to the current using the LEDs and resistors in projects 18 and 19.

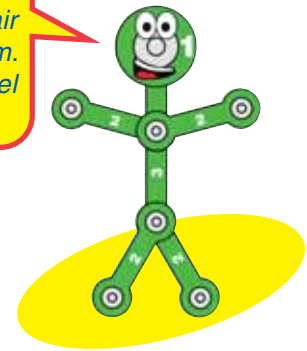





# Project #21

See projects 1 & 3 if you need to recharge the battery (B4).

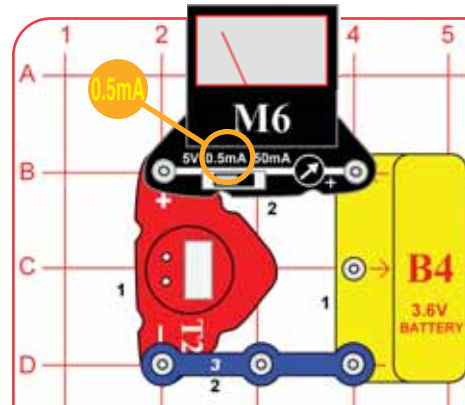

# Clock

The clock uses a liquid crystal display (LCD) to show the time. LCDs use very little power, but cannot be viewed in darkness. The electronic circuitry that keeps time, controls the display, and allows you to set the current time is complex but has been miniaturized in an integrated circuit (IC).

Build the circuit shown. Set the meter (M6) to the 0.5mA setting. The clock display will light, but the meter will not measure any current. See page 4 if you would like to set the time.

The clock needs only about 0.005mA of current to operate, and this is too small to measure on your meter. The battery can run the clock for a long time without being recharged.

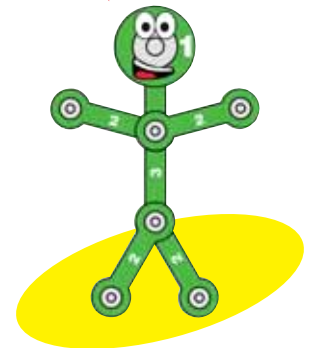

# Project #22

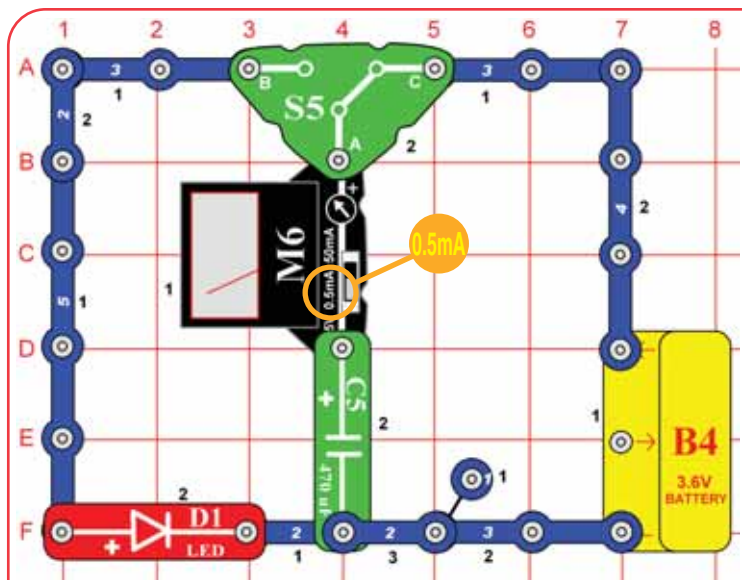

# Capacitor

Capacitors store electricity in an electric field between metal plates, with a small separation between them. This electric field is similar to the magnetic field of a magnet. Compared to batteries (which store energy as separated chemicals), capacitors can only store small amounts of energy, but they can release it quickly, can be made in very small sizes, and are inexpensive.

Build the circuit shown. Set the meter (M6) to the 0.5mA setting. Flip the slide switch (S5) back and forth to charge and discharge the 470µF capacitor (C5).

With the switch in position C, a electricity briefly flows from the battery into the capacitor to charge it up, as shown by the meter. With the switch in position B, the energy in the capacitor discharges through the red LED (D1), which flashes.

The meter only measures current in one direction, but you can flip it around to measure the discharge current.

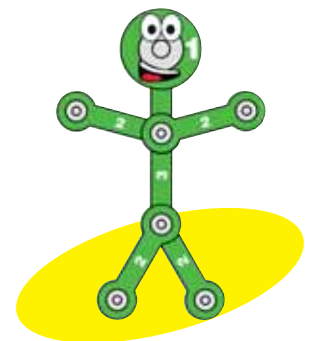

# Project #23

## Motor

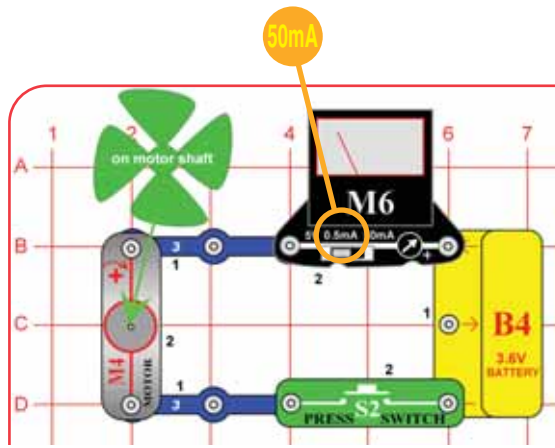

See projects 1 & 3 if you need to recharge the battery (B4).

How does electricity turn the shaft in the motor? The answer is magnetism. Electricity is closely related to magnetism, and an electric current flowing in a wire has a magnetic field similar to that of a very, very tiny magnet. Inside the motor is a coil of wire with many loops. If a large electric current flows through the loops, the magnetic effects become concentrated enough to move the coil. The motor has a magnet inside, so as the electricity moves the coil to align it with the permanent magnet, the shaft spins.

Build the circuit shown. Set the meter (M6) to the 50mA setting and place the wind fan on the motor (M4). Push the press switch (S2) and watch the current on the meter as the motor speeds up.

Do you know why the current drops as the fan speeds up?

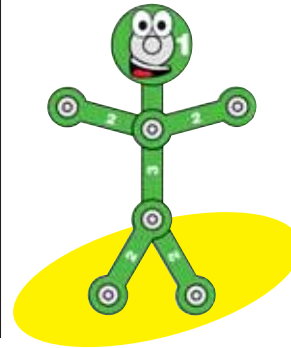

# Project #24

## Water Wheel

Remove the wind fan from the motor shaft and replace it with the water wheel. Watch how the current is different with the larger water wheel.

The water wheel is heavier, so it takes more current to spin it, and doesn't get as fast. Try laying something on the water wheel to give it even more weight.



# Project #25

## Motor Voltage

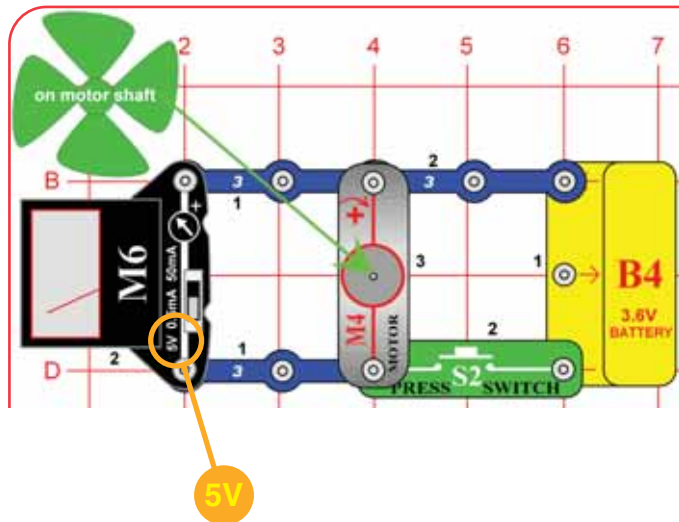

Modify the preceding circuit into this one. Set the meter (M6) to the 5V setting and place the wind fan on the motor (M4). Push and release the press switch (S2) and watch the voltage on the meter as the motor speeds up and slows down.

Without pressing the switch, spin the fan clockwise with your finger and watch the voltage. In the preceding project, the current dropped as the fan sped up - now you see why. The spinning fan produces a voltage in the motor; this voltage opposes the voltage from the battery, reducing the current as the motor speeds up.

How will the voltage and current change if you replace the wind fan with the water wheel? Try it.

Electricity is generated when you spin the motor shaft. A coil of wire is on the shaft, and as it spins past the permanent magnet an electric current is created in the wire.

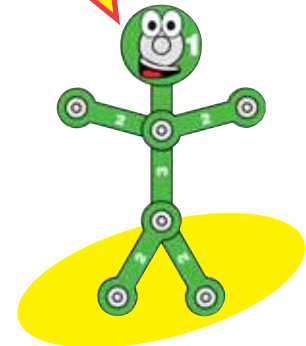



# Project #26

See projects 1 & 3 if you need to recharge the battery (B4).

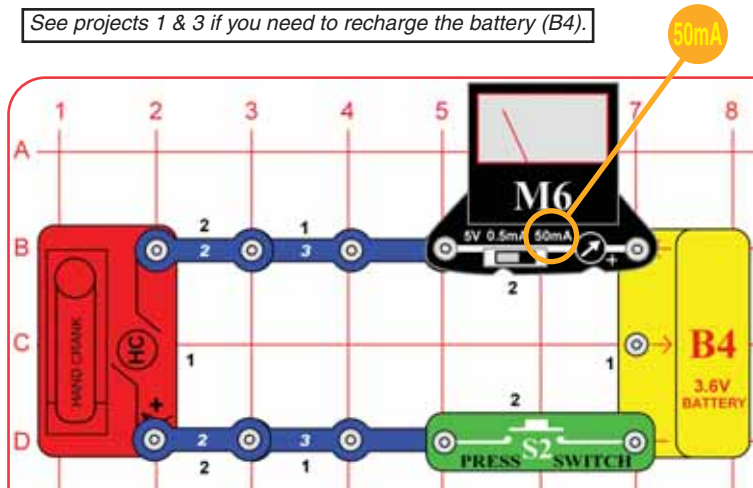

# Crank Motor

The hand crank is a motor with a gearbox attached. The gearbox spins the crank handle slower but with more force than when the motor shaft is spinning.

The slow-spinning crank handle may look boring compared to the fast wind fan on the M4 motor, but using a gearbox allows a low-power motor to move heavier objects than they normally could.

Build the circuit shown. Set the meter (M6) to the 50mA setting. Push the press switch (S2) and watch the current on the meter when the hand crank (HC) spins. Compare the current with it to the current when using the motor (M4) and other parts.

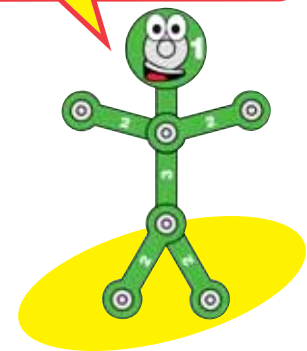

# Project #27

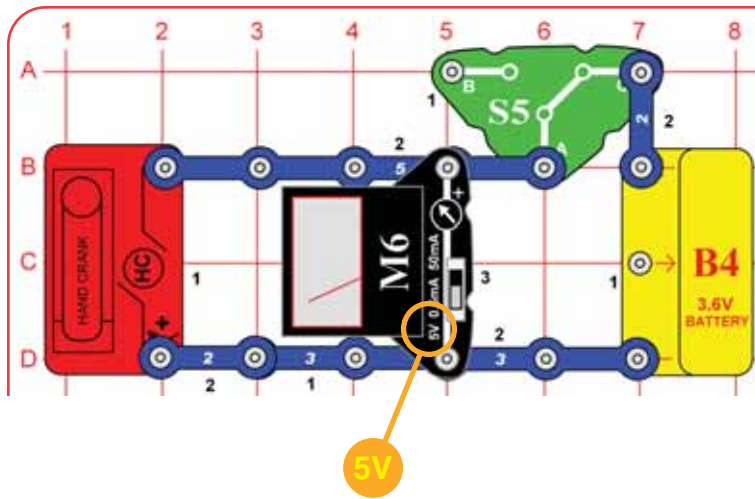

# Crank Motor Voltage

Modify the preceding circuit into this one. Set the meter (M6) to the 5V setting. Set the slide switch (S5) to position B and watch the voltage on the meter when the hand crank spins.

Set the slide switch to position B to disconnect the battery. Turn the crank handle counter-clockwise and see how much voltage you generate. You can switch the meter to the 50mA setting to see how much current you produce when you spin the fan.

Set the meter back to the 5V setting and the slide switch back to position C. While it is spinning, CAREFULLY AND WITHOUT USING MUCH FORCE, try to turn the crank handle in both directions. Feel how much easier or harder it is to turn the crank when the battery voltage is helping or opposing you. USING EXCESSIVE FORCE MAY DAMAGE THE HAND CRANK!

The motor in the hand crank is different from the M4 motor, but similar. Did you see how much more voltage and current you can generate using the hand crank than with the M4 motor?

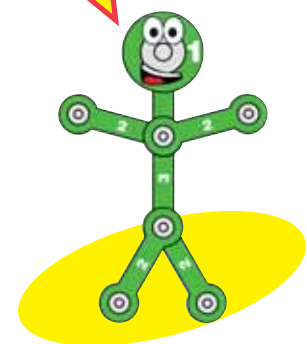



# Project #28

# Radio Current

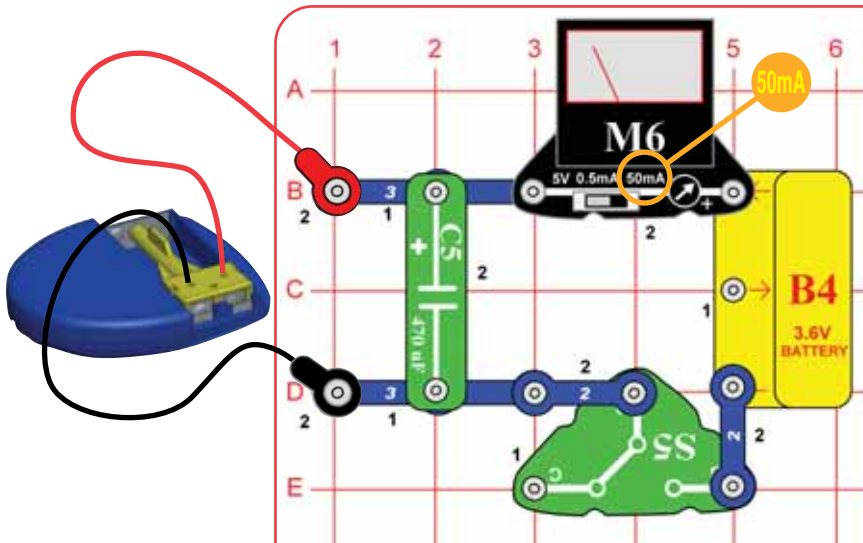

Install the battery eliminator connector into the battery compartment in the FM radio, as shown. Build the circuit as shown, and connect the red and black snap wires to it. Set the meter (M6) to the 50mA setting and the slide switch (S5) to position B. Plug the earphones into the radio and place them earphones in your ears. Turn the volume knob clockwise to turn on the radio, press the reset button, then press the scan button several times to find a radio station (radio features may vary).

Listen to the radio and notice how much current it needs. If the sound is distorted, then recharge the battery using the solar cell or other power sources in this kit.

Use the volume knob to turn off the radio and look at the current measured on the meter. Even though the radio is off, the current may not be zero. The battery eliminator is using the remaining current. The radio needs only 3V and can be damaged by higher voltages, so the battery eliminator has circuitry to reduce the higher voltages from the power sources in this kit to 3V (for example, the B4 battery is 3.6V, the solar cell can produce 7V, and the hand crank can produce more than 10V).

Your radio may have a light bulb or LED in it; if so, press the button to activate it. It may only light dimly, but notice what happens to the current and sound. Incandescent light bulbs need high current to get bright, much higher than LEDs. The radio may not work when the light is activated, due to circuitry in the battery eliminator, which protects the radio from overvoltage. The radio light will work if you use the radio with normal "AAA" type batteries (not included).

## INSTALLING BATTERY ELIMINATOR

- 1 Insert eliminator under belt clip
- 2 Press eliminator down into slot
- 3 Slide eliminator into position

See projects 1 & 3 if you need to recharge the battery (B4).

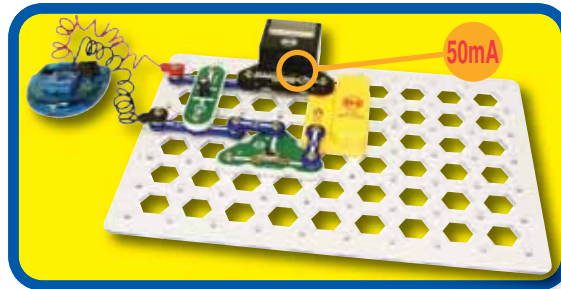

The 470 $\mu$ F capacitor (C5) is used here to improve sound quality by helping to stabilize the battery voltage. The radio needs a steady voltage to produce good sound quality, but the current it needs changes slightly as the sound changes. The capacitor can only supply a small amount of current but can react to changes faster than the battery can. Remove the capacitor from the circuit and see if you notice a difference in sound quality.



Note: Radio style and features may vary.

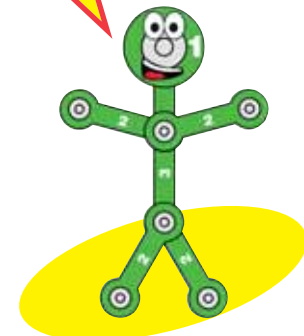



# Project #29

# Long Light

See projects 1 & 3 if you need to recharge the battery (B4).

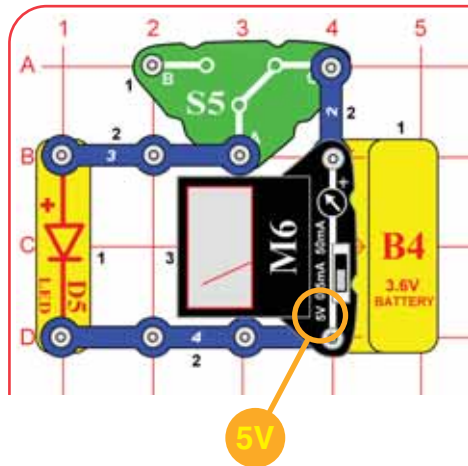

Build the circuit and set the meter (M6) to the 5V setting. Set the slide switch (S5) to position C and watch the voltage on the meter for a while as the battery runs the yellow LED (D5). How quickly does the voltage drop? Try placing the circuit in darkness, changing the temperature, or varying the wind.

If your battery was recently recharged then you probably found the voltage drops very, very slowly, and thought this was boring. That was the idea - batteries can run things for a long time and (unlike solar or wind power sources) are hardly affected by changing weather conditions. Batteries can provide power whenever you need it - but, eventually, they do run out.

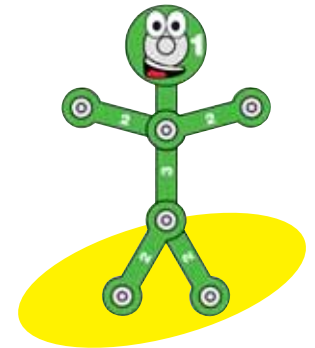

# Project #30

# LED Currents

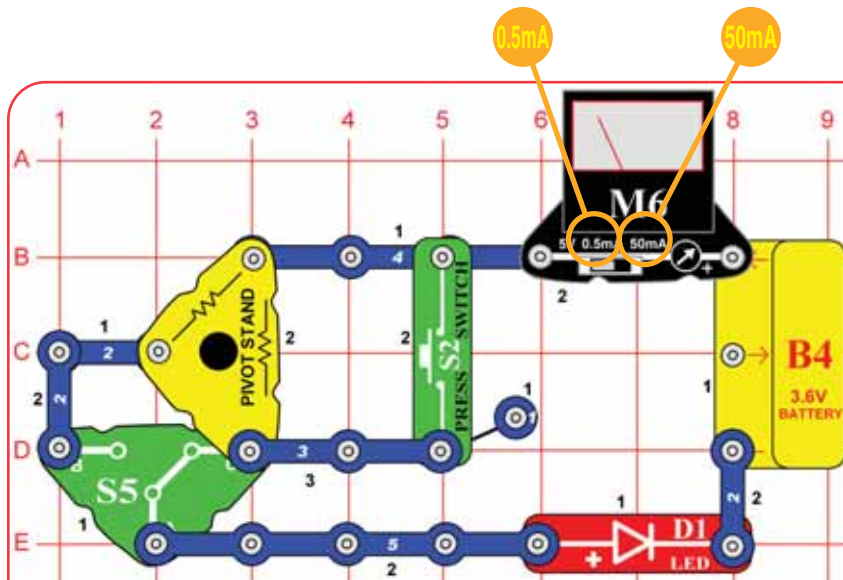

Build the circuit, set the slide switch (S5) to position B, and set the meter (M6) to the 0.5mA setting. This circuit has the LED in series with a 10KΩ resistor in the pivot stand. 10KΩ is a high resistance, so the meter measures a small current and the red LED (D1) is dimly lit. It is easier to see the red LED if you take the circuit into a dark room. If the LED does not light at all then the battery needs to be recharged.

Switch the meter to the 50mA setting. Now set the switch to position C, replacing the 10KΩ resistor with a smaller 47Ω resistor in the pivot stand. The LED is brighter now and the current is higher.

Now push the press switch to bypass the 47Ω resistor. The current and LED brightness are even higher now.

Replace the red LED with the yellow LED (D5) and see how the brightness and current change.

Adding resistors to a circuit is like partially blocking a water pipe, reducing the flow of water.

High currents can damage LEDs, so resistors are usually used with them to limit the current. Your D1 and D5 LEDs have internal resistors of around 50Ω to protect them.

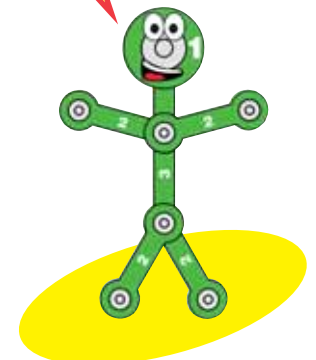



# Project #31

See projects 1 & 3 if you need to recharge the battery (B4).

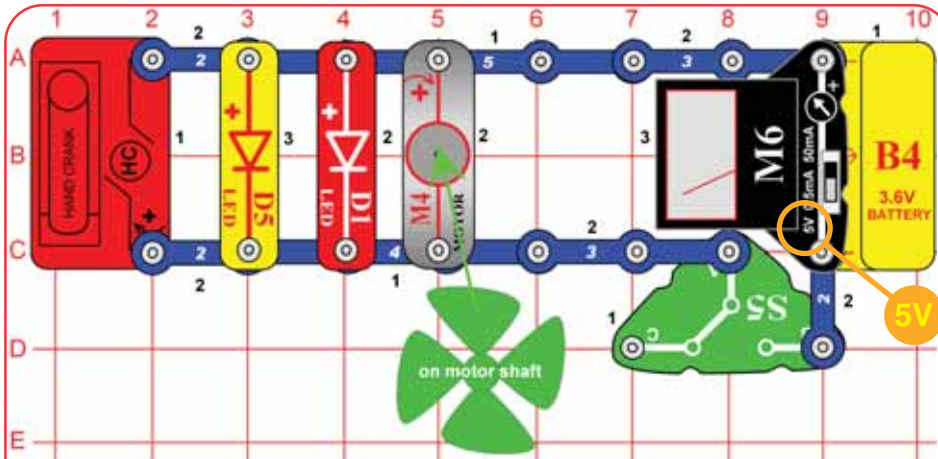

# Battery Load

The battery makes electricity using a chemical reaction, but has a limited amount of chemicals and not all of it can react at the same time. When a battery cannot supply as much current as a circuit needs, the voltage (electrical pressure) drops. That is why the voltage drops when the switch connects the battery to the rest of this circuit.

Engineers refer to all the devices a power source is running as the load, because they are the burden the power source is carrying.

Build the circuit and set the meter (M6) to the 5V setting. Set the slide switch (S5) to position C and read the battery (B4) voltage when it is not running anything.

Now set the switch to position B and see what happens to the voltage when everything turns on. If the battery is already weak, some modules may not start. If you watch the voltage for a while, you will see it slowly drop as the battery is discharged. If the battery was already weak, the voltage will drop faster.

If you remove some of the devices the battery is running (the LEDs, motor, and hand crank), then the voltage will not drop as much when the switch is turned on.

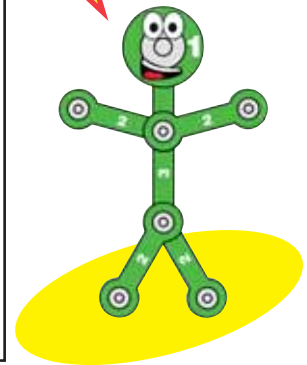

# Project #32

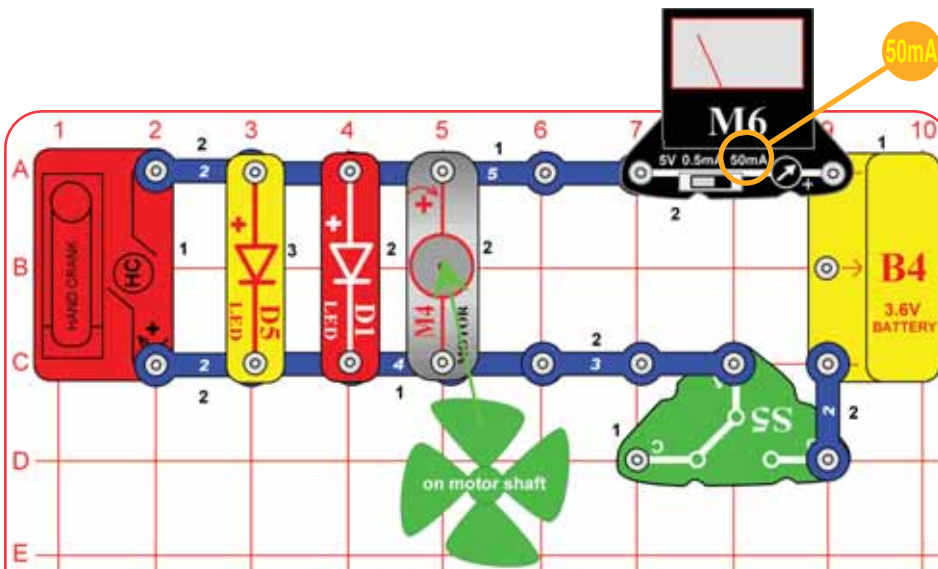

# Battery Load Current

Move the meter to the new location shown and set the meter (M6) to the 50mA setting. Set the slide switch (S5) to position B and see how high the current is when the battery is running all these devices.

You may see that the current is very high, which explains why the battery voltage dropped in the preceding project. Do you know which devices need most of the current? Remove some and see how the current changes to see if you were right.

Your M6 meter is a simple meter, don't expect it to be as accurate as normal electronic test instruments.

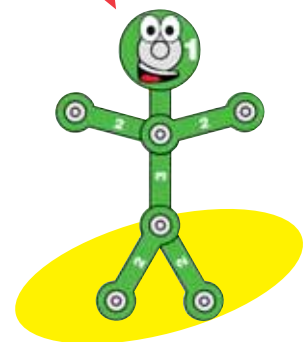

# Project #33

# Make Your Own Parts

See projects 1 & 3 if you need to recharge the battery (B4).

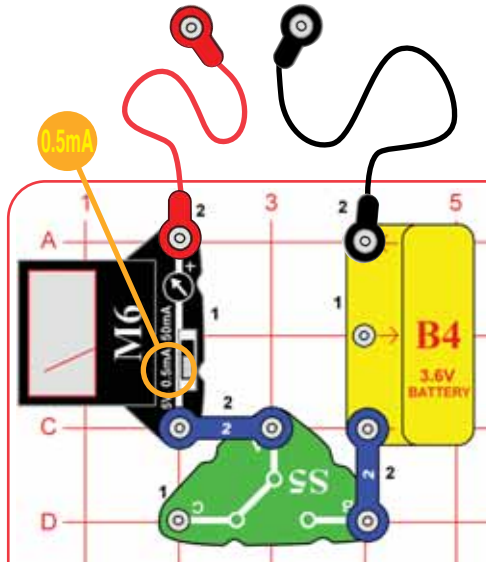

**Method A (easy):** Spread some water on the table into puddles of different shapes, perhaps like the ones shown here. Touch the jumper wires to points at the ends of the puddles.



**Method B (challenging):** Use a SHARP pencil (No. 2 lead is best) and draw shapes, such as the ones here. Draw them on a hard, flat surface. Press hard and fill in several times until you have a thick, even layer of pencil lead. Touch the jumper wires to points at the ends of the drawings. You may get better electrical contact if you wet the metal with a few drops of water. Wash your hands when finished.

**Method C (adult supervision and permission required):** Change the setting on the meter to the 50mA scale. Use some double-sided pencils if available, or VERY CAREFULLY break a pencil in half. Touch the jumper wires to the black core of the pencil at both ends.



Resistance = Voltage / Current, so you can use the battery voltage (3.6V) and the current you measure to find the resistance of your puddles and drawings.

Long narrow shapes have more resistance than short wide ones. The black core of pencils is graphite, the same material used in the resistors in the pivot stand.

Build the circuit, set the meter (M6) to the 0.5mA setting, and set the slide switch (S5) to position B.

Make your parts using either the water puddles method (A), the drawn parts method (B), or the pencil parts method (C). Touch the metal in the jumper wires to your parts and read the current.

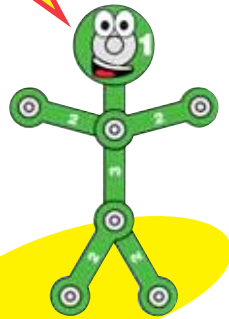

# Project #34 Liquid Resistors

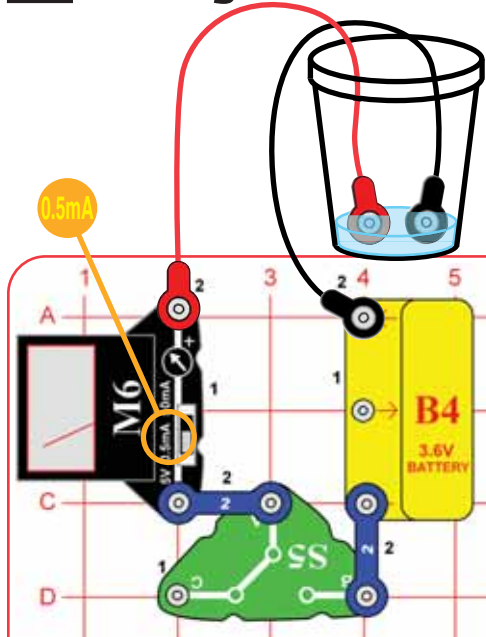

Build the circuit, set the meter (M6) to the 0.5mA setting, and set the slide switch (S5) to position B. Add about 1/4 inch of water to a cup or bowl. Connect the jumper wires to the circuit as shown and place the loose ends in the water, make sure the metal parts aren't touching each other. Measure the current through the water.

Add salt to the water and stir to dissolve it. The current should be higher now, since salt water has less resistance than plain water. If the current is too high to measure on the 0.5mA scale, switch to the 50mA scale.

Now add more water to the cup and watch the current. If you have some distilled water, place the jumper wires in it and measure the current. You should measure close to zero current, since distilled (pure) water has very high resistance. Normal water has impurities, which lower its resistance. Now add salt to the distilled water and watch the current increase as the salt dissolves!

You can also measure the current through other liquids. Don't drink any water or liquids used here.

Pure water has very high resistance because its electrons are tightly held in place. Impurities (such as dissolved dirt, minerals, or salt) decrease the resistance because they have loose electrons, which disrupt the structure and make it easier for other electrons to move through.

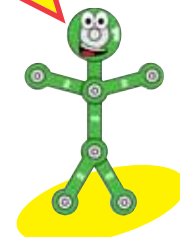

# Project #35 Liquid Light

Replace the meter with the red LED (D1, + on top). Place the jumper wires back into water, into salt water, or on the shapes you drew.





# Project #36

# Moving Voltage

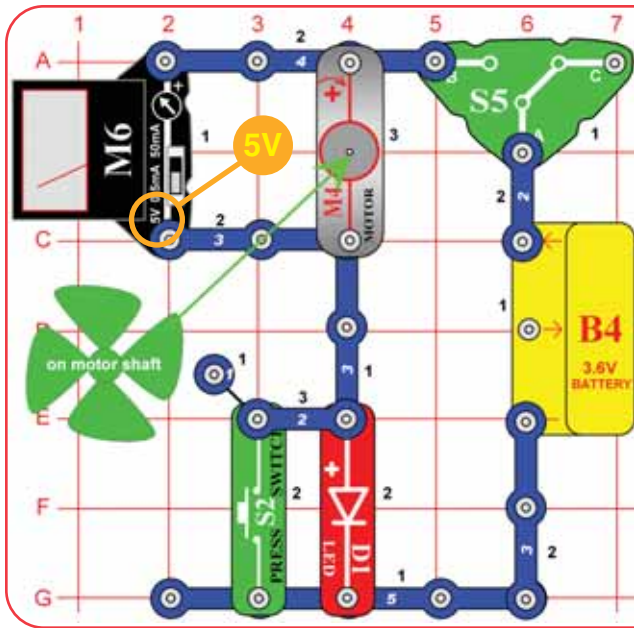

See projects 1 & 3 if you need to recharge the battery (B4).

Build the circuit and set the meter (M6) to the 5V setting. Place the wind fan on the motor (M4). Set the slide switch (S5) to position B. The red LED (D1) lights, the fan spins, and the meter shows the voltage across the motor. You may need to give the fan a push to get it started. The voltage produced by the battery is split between the motor and the LED.

Push the press switch (S2). The LED turns off, the motor speeds up, and the meter shows a higher voltage across the motor. With the press switch on, the full voltage from the battery is available at the motor because the LED is bypassed.

Switches are used to move voltage around a circuit.

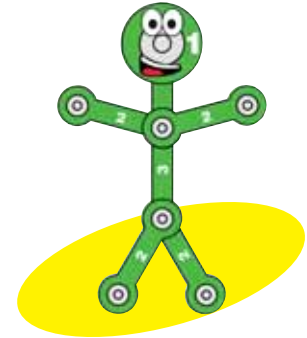

# Project #37

# Moving More Voltage

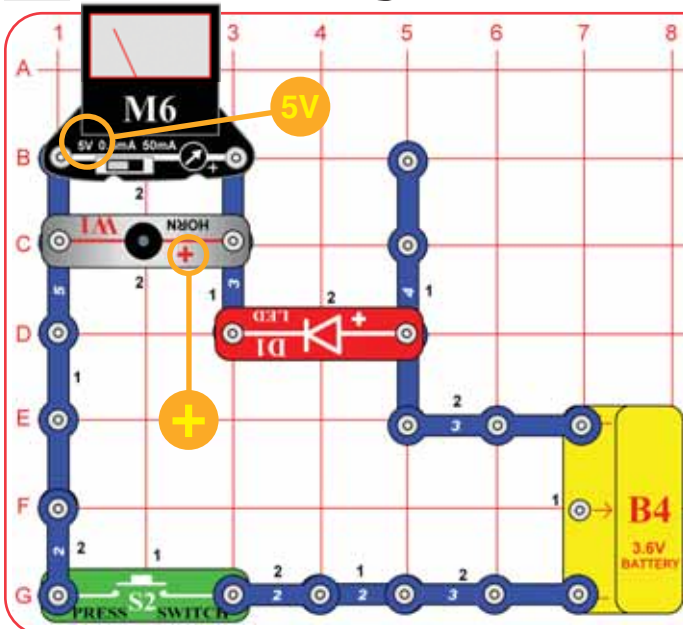

Part B



The horn voltage plus the LED voltage should about equal the battery voltage. It may be a little different, because the M6 meter has limited accuracy. The voltage across the switch will be very low when it is pressed.

Part C

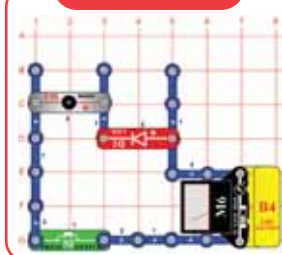

Build the circuit and set the meter (M6) to the 5V setting. Push the switch (S2); the meter measures the voltage across the horn (W1).

Part B: Move the meter so it is across the red LED (D1). Push the switch to measure the voltage across the LED.

Part C: Move the meter so it is directly across the battery (B4). Push the switch to measure the voltage produced by the battery.

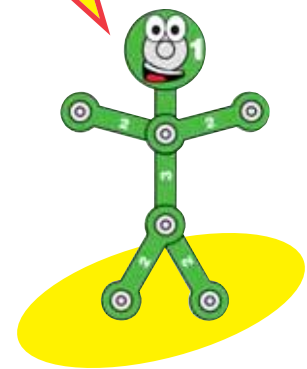



# Project #38

# Power Sources

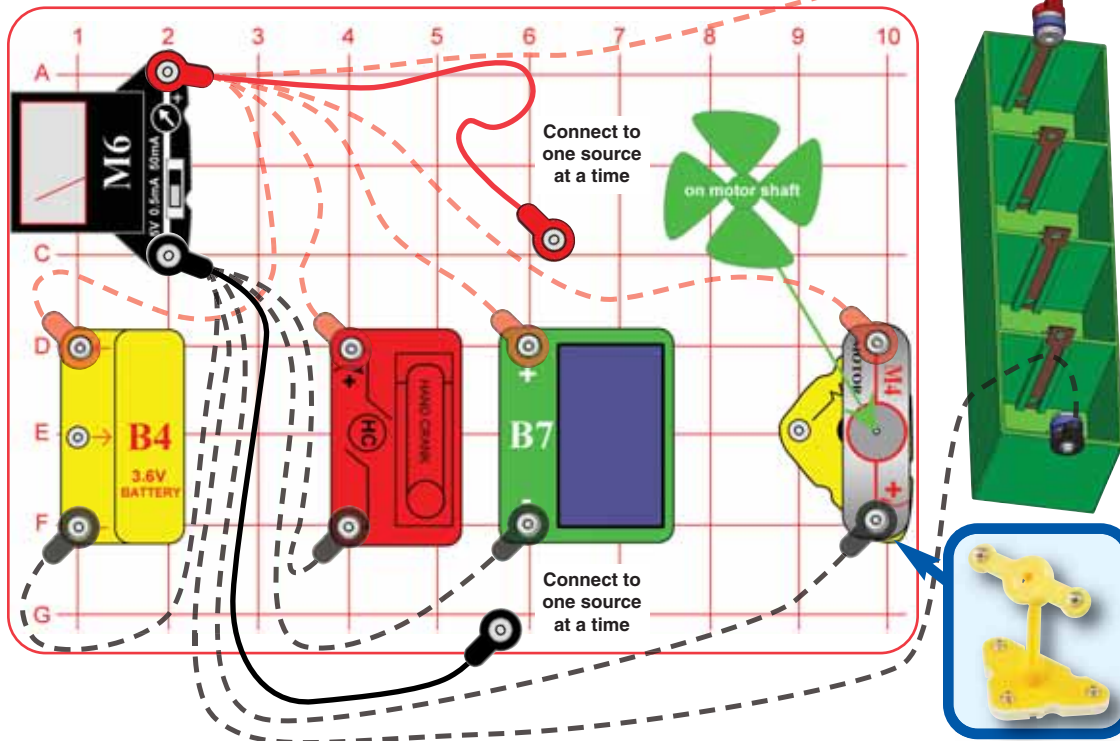

Snap Circuits® Green has 6 electrical power sources: battery, hand crank, solar cell, windmill, watermill, and liquid holder. Let's compare them. The watermill is similar to the windmill and its messy, so we'll skip it.

Connect the red & black jumper wires to the meter and to one of the power sources at a time, as shown. Measure the voltage produced using the 5V meter setting; then look at the current produced using either the 0.5mA or the 50mA meter settings. Some times the meter reading will be more than the 5V or 50mA scales. Take some notes in the table below.

- A. Battery.
- B. Hand Crank: Turn it clockwise at different speeds.
- C. Solar cell: Place it in sunlight or near an incandescent lamp.
- D. Windmill: Mount the motor on the pivot stand, place the wind fan on it, and blow on it or place it in a strong wind. You may need to give it a push to get it started.
- E. Liquid energy source: Assemble it using the instructions on page 4. Fill the compartments with cola or juice.

See projects 1 & 3 if you need to recharge the battery (B4).

The most powerful power source is the one which produces the best balance of voltage and current. Different types of circuits need different levels of voltage and current.

For each power source, the balance between voltage and current produced can be adjusted by changing its construction or with how groups of them are arranged.

| Power Source | Highest Meter Voltage | Highest Meter Current | Clock (Project 39) | Horn (Project 40) | Yellow LED (Project 41) | Big Voltage (Project 42) | Big Current (Project 43) |
|--------------|-----------------------|-----------------------|--------------------|-------------------|-------------------------|--------------------------|--------------------------|
| Battery      |                       |                       |                    |                   |                         |                          |                          |
| Hand Crank   |                       |                       |                    |                   |                         |                          |                          |
| Solar Cell   |                       |                       |                    |                   |                         |                          |                          |
| Windmill     |                       |                       |                    |                   |                         |                          |                          |
| Liquid       |                       |                       |                    |                   |                         |                          |                          |

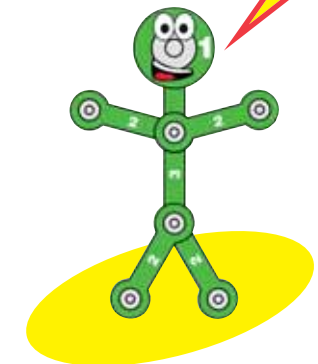

## Project #39 Powering Clock



Use the 5 power sources you have set up in project 38 but replace the meter with the clock (T2) as shown. See if it works with each power source (it should). Take some notes in the project 38 table - it has a column for the clock.

You are not using the clock with a separate energy storage device, so notice how continuous power is from each source (for example, the clock stops when you stop turning the hand crank).

## Project #40 Powering Horn

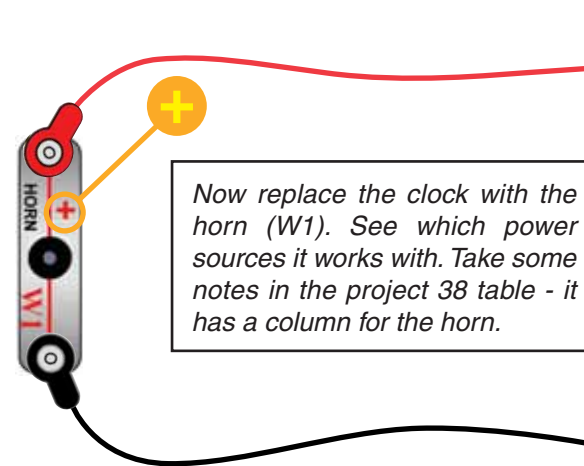

Now replace the clock with the horn (W1). See which power sources it works with. Take some notes in the project 38 table - it has a column for the horn.

## Project #41 Powering LED

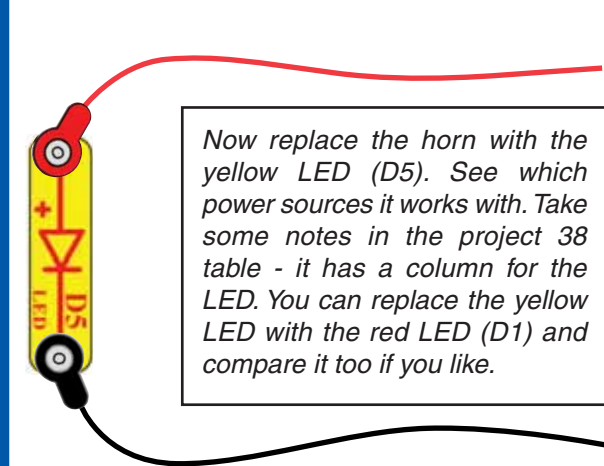

Now replace the horn with the yellow LED (D5). See which power sources it works with. Take some notes in the project 38 table - it has a column for the LED. You can replace the yellow LED with the red LED (D1) and compare it too if you like.

## Project #42 Powering Big Voltage

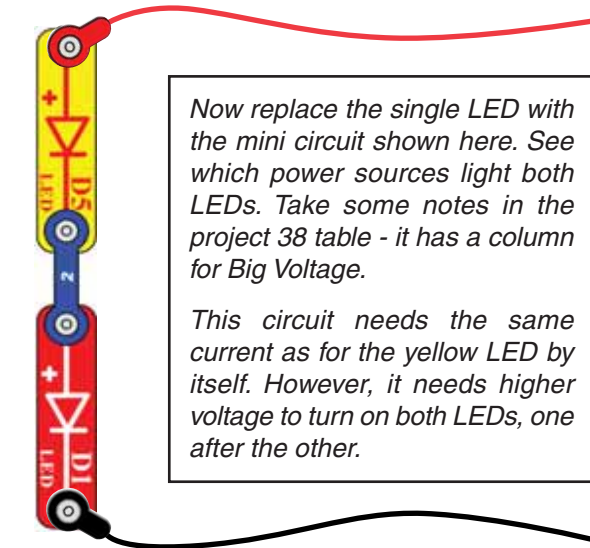

Now replace the single LED with the mini circuit shown here. See which power sources light both LEDs. Take some notes in the project 38 table - it has a column for Big Voltage.

This circuit needs the same current as for the yellow LED by itself. However, it needs higher voltage to turn on both LEDs, one after the other.

## Project #43 Powering Big Current

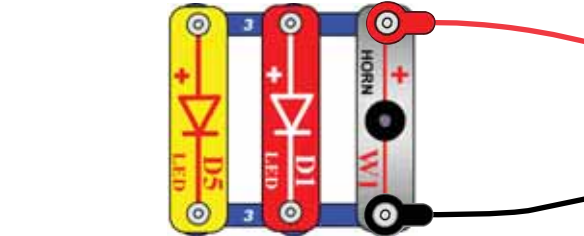

Now change to this mini circuit instead. Find out which power sources can run both LEDs and the horn. Take some notes in the project 38 table - it has a column for Big Current.

This circuit needs about the same voltage as for the yellow LED by itself, but it needs higher current to turn on both LEDs and the horn all at the same time.

Each power source has advantages and limitations:

- Batteries have lots of power but they only store energy, they don't actually produce it.
- The hand crank has lots of power but only while you are turning the crank.
- The solar cell has limited power, and only while it has light.
- The windmill makes good power but only in a strong wind.
- The liquid energy source has very little power.

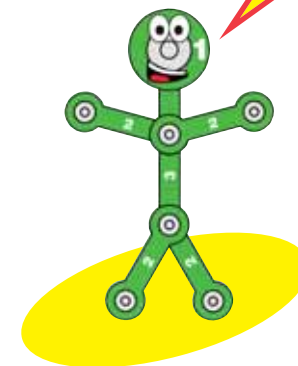



# Project #44

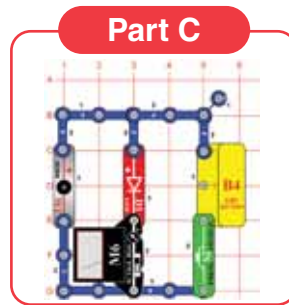
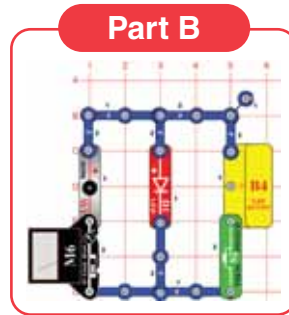
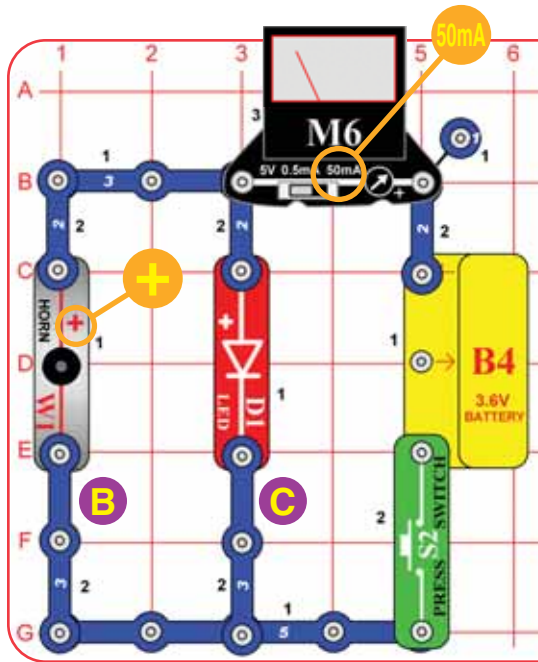

# Splitting Current

The current from the battery splits up between the horn and the LED. If you add up the current you measured through the horn and LED (Parts B & C), it should be the same as the current you measured from the battery. (Your result may be a little different, because M6 is a simple meter with low accuracy.)

Build the circuit and set the meter (M6) to the 50mA setting. Push the switch (S2); the meter measures the current from the battery (B4).

Part B: swap the location of the meter with the 3-snap wire marked "B" ("+" side towards the horn (W1)). Push the switch to measure the current through the horn.

Part C: swap the "B" location of the meter with the "C" 3-snap. Push the switch to measure the current through the red LED (D1).

See projects 1 & 3 if you need to recharge the battery (B4).

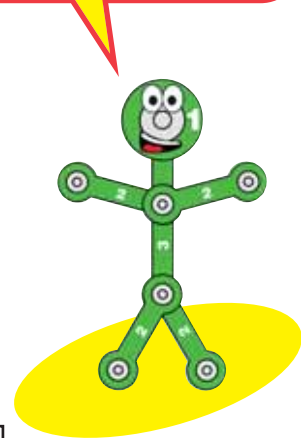

# Project #45 Splitting Current Differently



Replace the horn or red LED with the motor (M4, with wind fan blade) or yellow LED (D5). Try different combinations and see how the current changes.



# Project #46 Splitting Different Currents

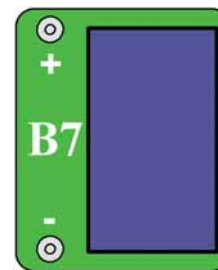

Replace the battery (B4) with the solar cell (B7). Try different combinations and see how the current changes.



# Project #47

See projects 1 & 3 if you need to recharge the battery (B4).

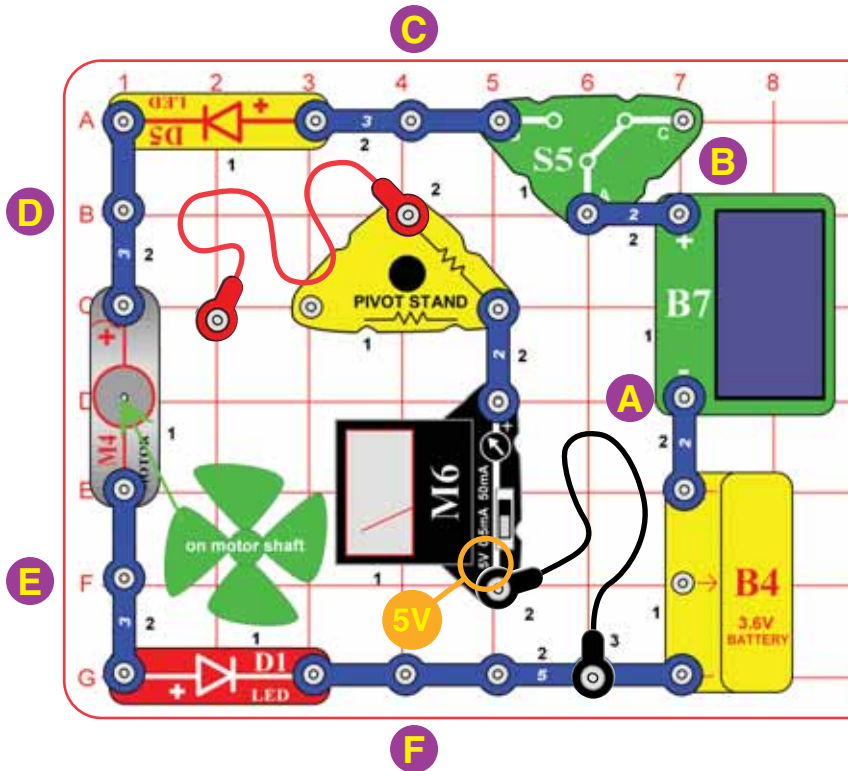

Build the circuit and place the wind fan on the motor (M4). Set the meter (M6) to the 5V setting. Connect the black jumper wire between the meter and 5-snap wire. Connect one end of the red jumper wire to the pivot stand; leave the other end loose. Set the slide switch (S5) to position B. Place the solar cell (B7) in bright sunlight or near an incandescent lamp. If the light is bright enough, the LEDs (D1 & D5) will light and the fan will spin. You may need to give the fan a push to get it started.

# Voltage Order

This circuit has the battery (B4) and solar cell producing voltage to push electric current through the LEDs and motor. Although the meter is set to the 5V scale, a resistor in the pivot stand changes the voltage scale to 10V, so double the voltage you read on the meter.

- Connect the loose end of the red jumper wire to the snap marked A to measure the voltage between there and the black jumper wire's location. It is just the voltage across the battery.
- Move the end of the red jumper from point A to point B, to see how much the voltage is increased by the solar cell.
- Move the end of the red jumper from point B to point C, to see how much the voltage changed across the switch.
- Move the end of the red jumper from point C to point D, to see how much the voltage was reduced as it pushed current through the yellow LED.
- Move the end of the red jumper from point D to point E, to see how much the voltage was reduced as it pushed current through the motor.
- Finally, move the end of the red jumper from point E to point F, to see how much the voltage was reduced as it pushed current through the red LED.

Part 2: Take the end of the black jumper wire off the 5-snap wire. Place the loose ends of the red and black jumper wires across any two points in the circuit to measure the voltage change between them (remember that the meter only measures positive voltages).

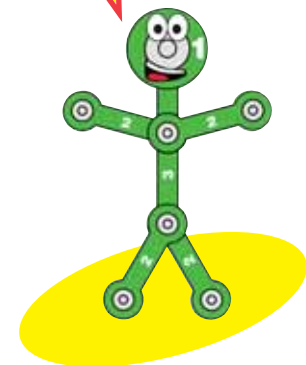



# Project #48

# Current Order

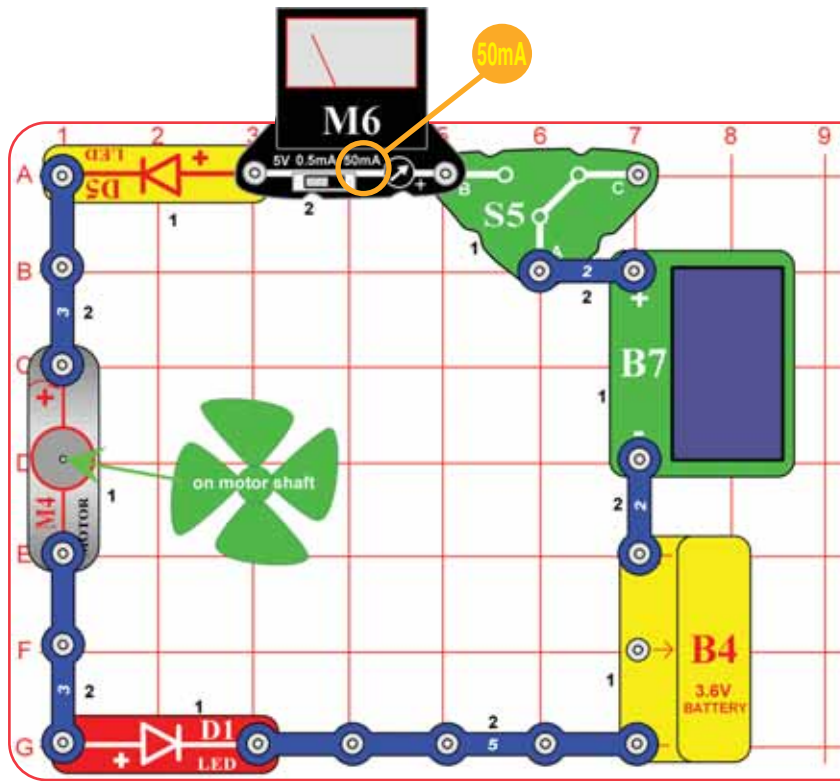

Build the circuit; it has the parts arranged in a loop. Place the wind fan on the motor (M4). Set the meter (M6) to the 50mA setting. Set the slide switch (S5) to position B. Place the solar cell (B7) in bright sunlight or near an incandescent lamp. If the light is bright enough, the meter will show a current, the LEDs (D1 & D5) will light, and the fan will spin. You may need to give the fan a push to get it started. If the meter shows zero, you can use the 0.5mA setting.

Part B: Rearrange the parts around the loop into the order shown, or any similar order you like. Keep the "+" side of the parts in the same direction as you move parts around the loop, and keep the light on the solar cell the same as before. The LED brightness, fan speed, and current shown on the meter should be the same no matter how you order the parts.

## Part B

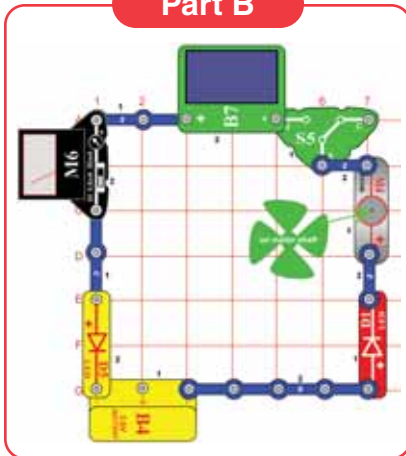

This circuit has the battery (B4) and solar cell producing voltage to push electric current through the LEDs and motor. The current is flowing counter-clockwise around the loop, and is the same through all parts. If you rearrange the parts in the loop, without changing their "+" orientation to the flow of current, then you have exactly the same circuit.

See projects 1 & 3 if you need to recharge the battery (B4).

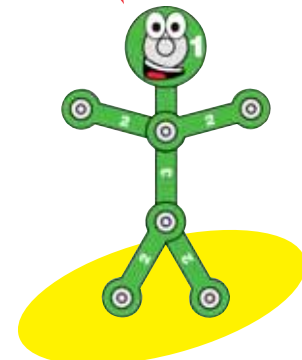



# Project #49

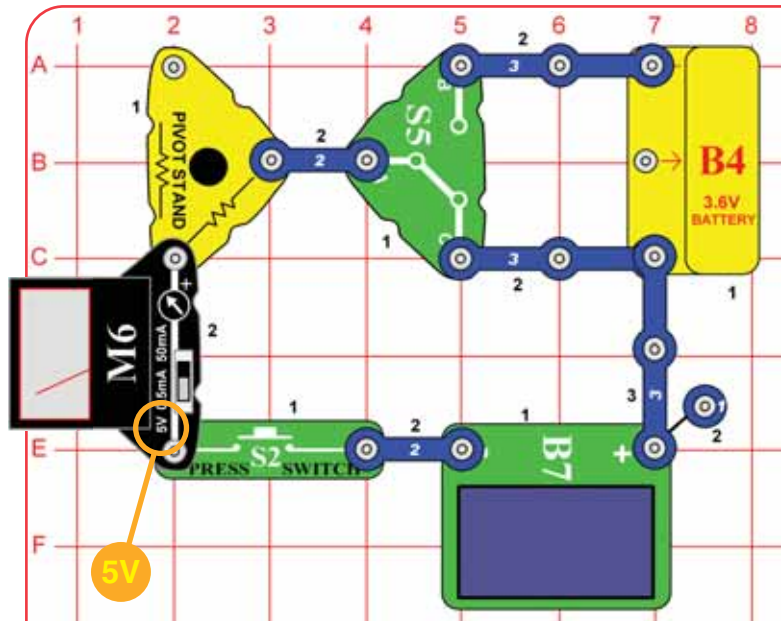

See projects 1 & 3 if you need to recharge the battery (B4).

Build the circuit shown. Place the solar cell (B7) in sunlight or close to an incandescent lamp. Set the meter to the 5V setting, but double the reading it shows, since a resistor in the pivot stand converts the scale to 10V. Push the press switch (S2). If the slide switch (S5) is set to position B, then the meter shows the combined battery (B4) and solar cell (B7) voltage. If it is set to position C, then the meter shows only the solar cell voltage.

Vary the light on the solar cell and see how the voltage changes.

The voltage produced will be lower when these sources are running something that needs lots of current, because the solar cell can only produce a small amount of current.

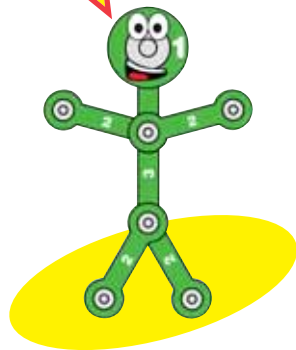

# Project #50

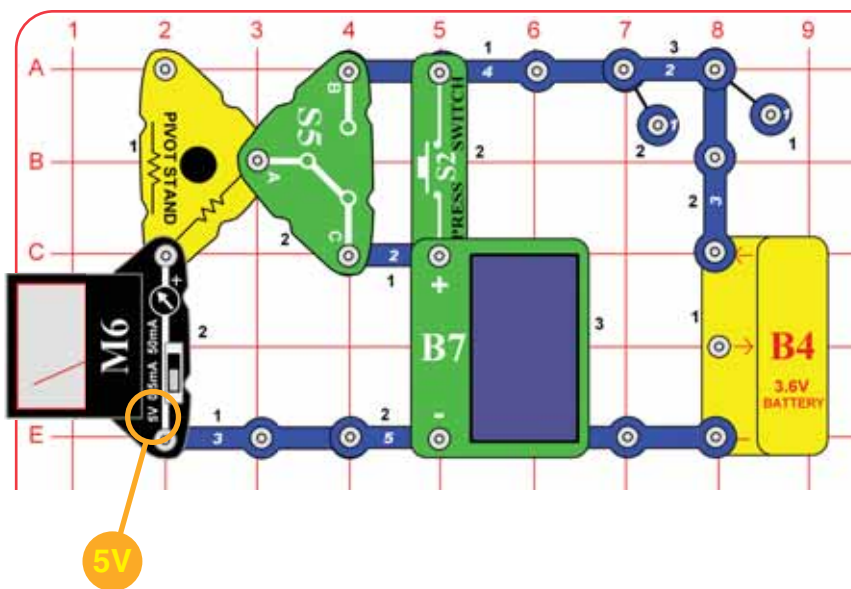

Build the circuit shown. Place the solar cell (B7) in sunlight or close to an incandescent lamp. Set the meter to the 5V setting, but double the reading it shows, since a resistor in the pivot stand converts the scale to 10V. If the slide switch (S5) is set to position B, then the meter shows the battery (B4) voltage. If it is set to position C, then the meter shows the solar cell (B7) voltage.

If you push the press switch (S2), then the battery and solar cell are connected in parallel with each other, and the meter shows the resulting voltage. Vary the light on the solar cell and see how the total voltage changes.

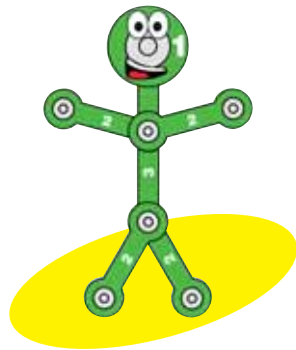



# Project #51

See projects 1 & 3 if you need to recharge the battery (B4).

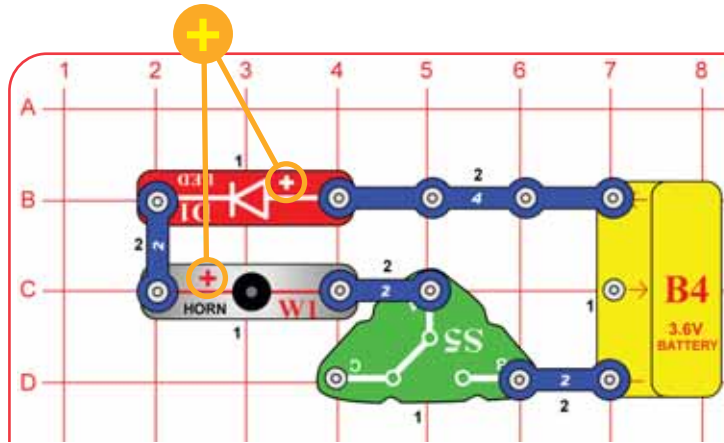

Set the switch (S5) to position B, the red LED (D1) lights and the horn (W1) sounds. Current flows from the batteries through the LED and horn back to the battery through the switch.

The closed switch completes the circuit. In electronics this is called a closed circuit. When the switch is set to "C", the current can no longer flow back to the battery, so the LED goes out and the horn stops making noise. In electronics this is called an open circuit.

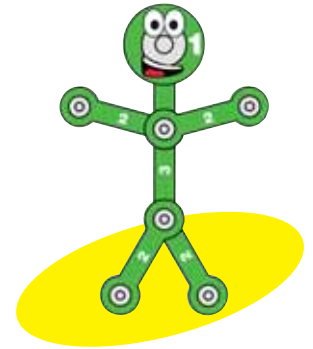

# Project #52

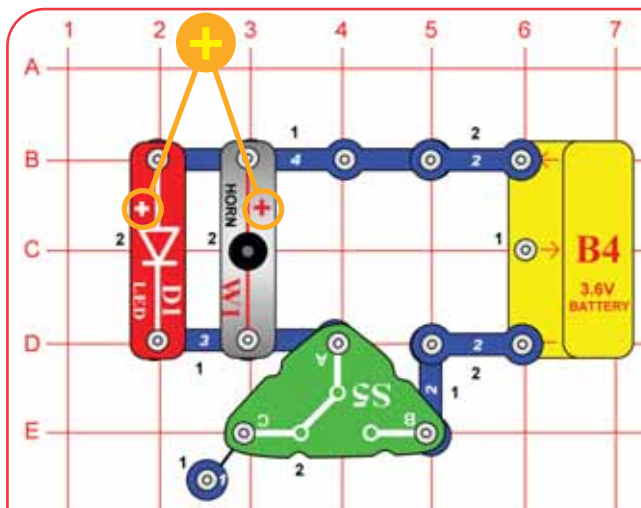

When you close the switch, both the LED and horn turn on. Current flows from the batteries through the LED and horn back to the battery through the switch.

Remove the horn and notice that the LED does not change in brightness. In a parallel circuit, current has more than one path so removing the horn does not affect the LED. The voltage is the same across the LED and horn, but not the current.

The lights in your home are wired in parallel so if one burns out, the others stay on.

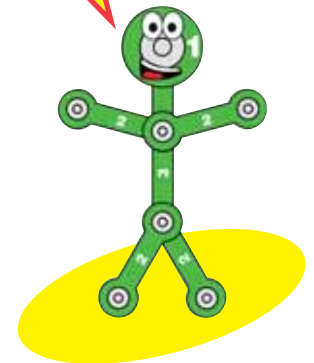



# Project #53

See projects 1 & 3 if you need to recharge the battery (B4).

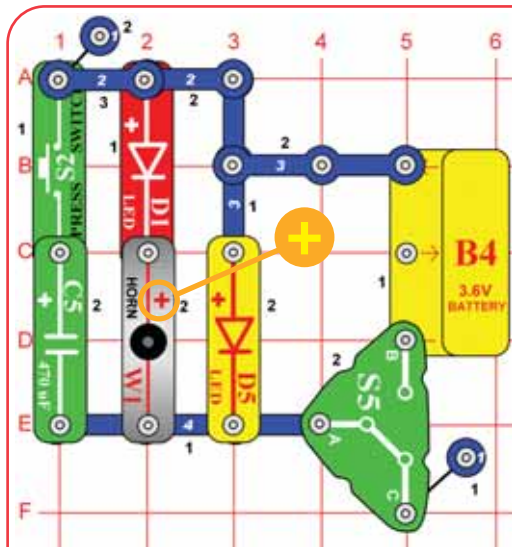

# Sound Starter

The voltage produced will be lower when these sources are running something that needs lots of current, because the solar cell can only produce a small amount of current.

Set the slide switch (S5) to position B. The LEDs (D1 & D5) light but there is little or no sound. Push the press switch (S2) to make the sound work.

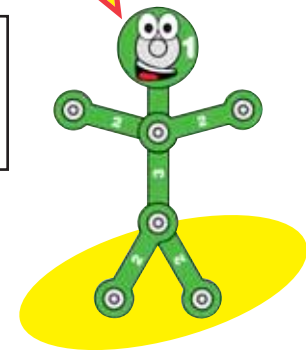

# Project #54

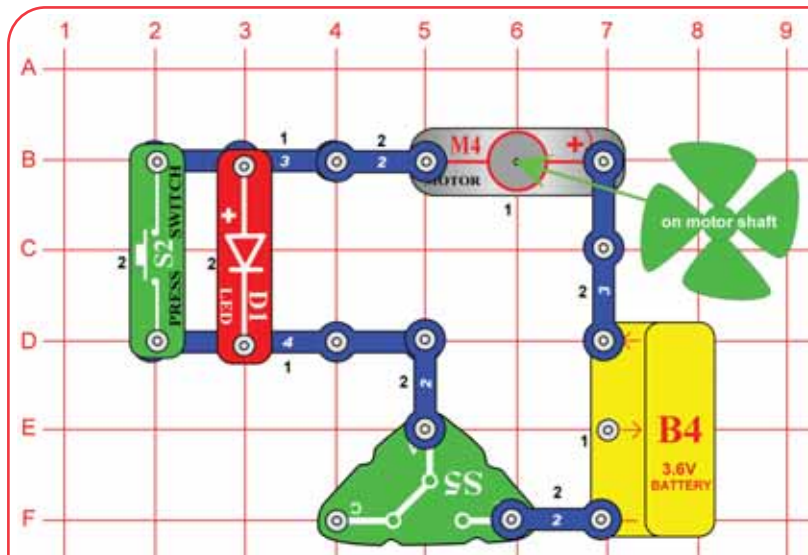

# Two Speed Motor

Set the slide switch (S5) to position B; the fan spins and the red LED (D1) turns on, indicating slow mode. The LED helps protect the motor from getting the full voltage when the slide switch is closed. Part of the voltage goes across the LED and the rest goes across the motor (M4).  
Pushing the press switch (S2) bypasses the red LED and now all the voltage is across the motor, so it spins faster.  
While the fan spins, carefully use your finger to speed it up; the LED should turn off. As the motor spins faster, its resistance increases and voltage across it rises. Now there is not enough voltage to light the LED until the motor slows down again.

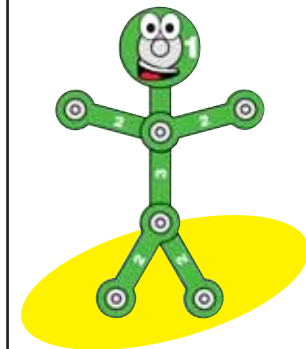





# Project #55

# Big Blade Wind Horn

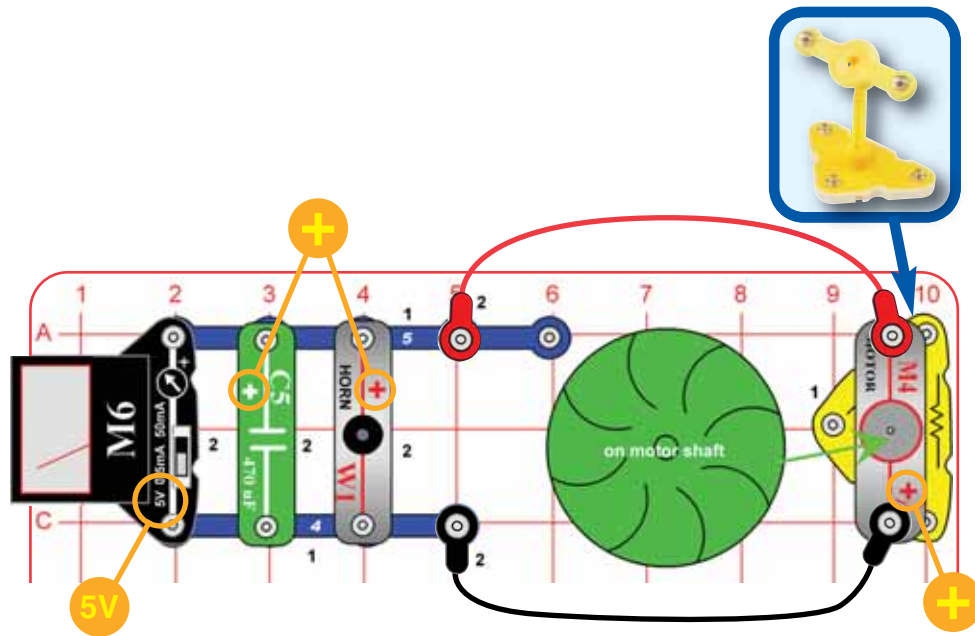

Place the water wheel on the motor (M4) and mount the motor on the pivot. Connect the red and black snap wires to the circuit as shown. Set the meter (M6) to the 5V setting.

Hold the "water-windmill" in a strong, steady wind (such as near an electric fan), and adjust its position on the pivot to get the highest voltage on the meter. If the wind is strong enough, the horn will sound. Blocking the wind on one side of the fan with your hand may direct the air flow better and make the fan work better.

The water wheel was made to use with water, but wind can push it too.

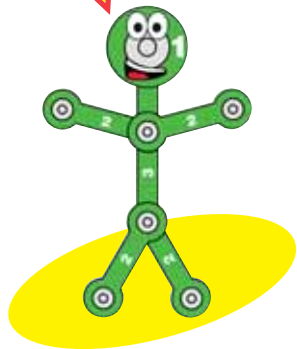

# Project #56

# Windy Time

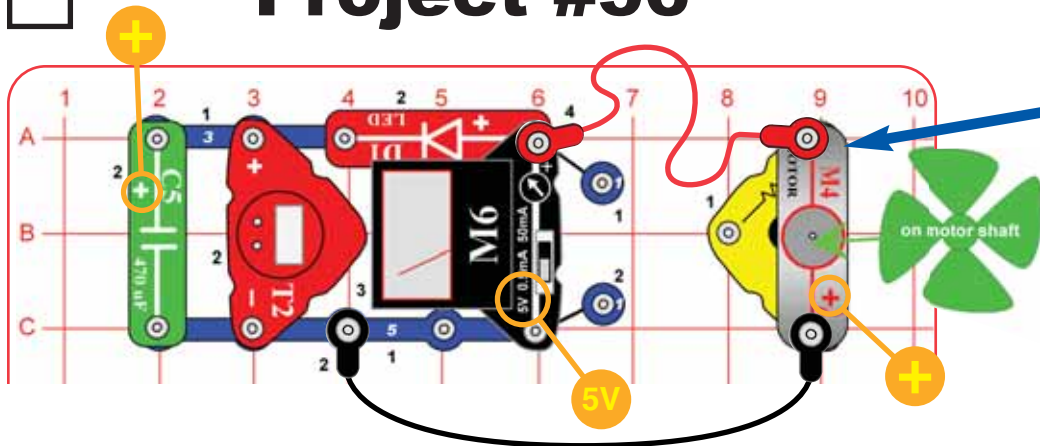

The 470µF capacitor (C5) can store a small amount of electricity. The clock needs very little electricity to operate, so the capacitor can run it for a while when the wind is not blowing.

The red LED is like a one-way light, only allowing electricity to flow in one direction. Here it is used to prevent electricity stored in the capacitor from discharging through the motor when the wind is not blowing.

Build the circuit shown. Set the meter to the 5V setting. Blow on the fan or place it in a strong wind (either outside or near an electric fan). The meter measures how much voltage your "windmill" produces. You may need to give the fan a push to get it started.

The clock display (T2) should be on, and stay on for a while when the wind is not blowing. Together the "windmill" and capacitor can run the clock using free, clean wind power. The red LED (D1) will not light.

If you would like to set the time on the clock, see page 4.

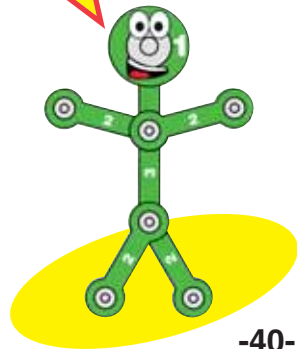

# Project #57

# Wind Charger with Light

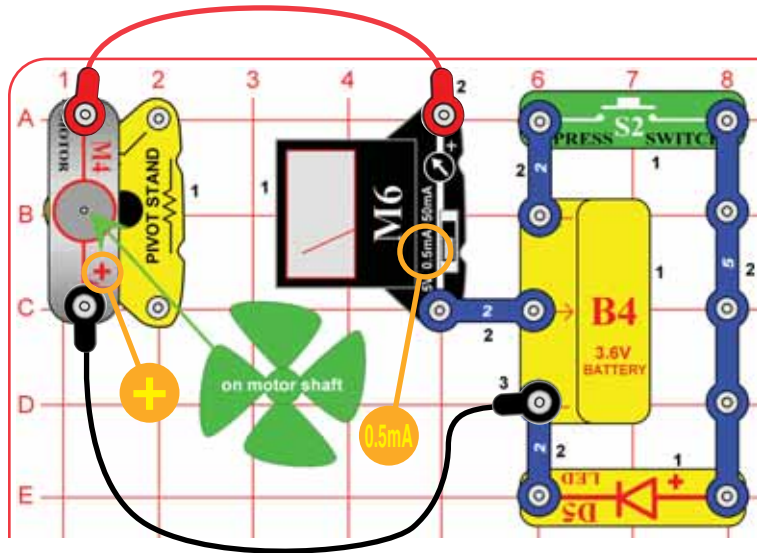

A problem with using wind to power a light is that the wind isn't always blowing when you need the light on. On the other hand, the wind is often blowing when you don't need the light on. So here you use the battery to store energy from the windmill when the wind is blowing, and then run the yellow LED when you need the light on. This way light is always available from clean, free wind power.

Build the circuit shown. Set the meter (M6) to the 0.5mA setting. Blow hard on the fan or place it in a very strong wind (either outside or near an electric fan). The "windmill" charges the battery (B4) when the wind is blowing hard, and the meter measures the charging current. Push the press switch (S2) to turn on the yellow LED (D5).

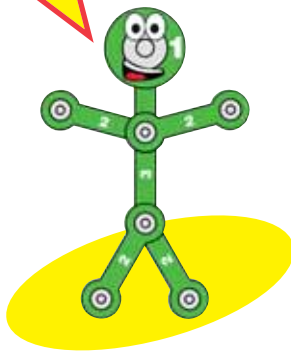

# Project #58 Wind Charger with Horn

Ice Storage units utilize a conventional air conditioner to make ice at off hours using off-peak electricity that is often sold at lower rates. The ice is stored in a large, well-insulated tank. When there is demand for air conditioning, refrigerant is circulated through coils in the ice. The chilled refrigerant then flows through the building's air-conditioning system inside the home or business to provide cooling.

Replace the yellow LED (D5) with the horn (W1, "+" on right"). The circuit works the same except pressing the switch makes sound from the horn. Here the horn is run using wind power, by using the battery for storage.

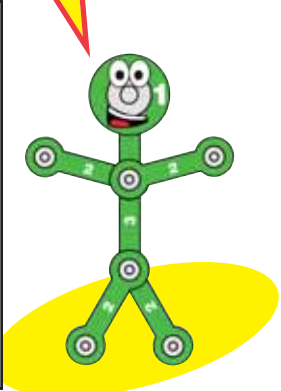

# Project #59

# Kick Start Motor

When this technique is used, they call the capacitor a "Starting Capacitor". A capacitor start motor is a split-phase induction motor with a starting capacitor inserted in series with the startup winding, creating a much greater starting torque.

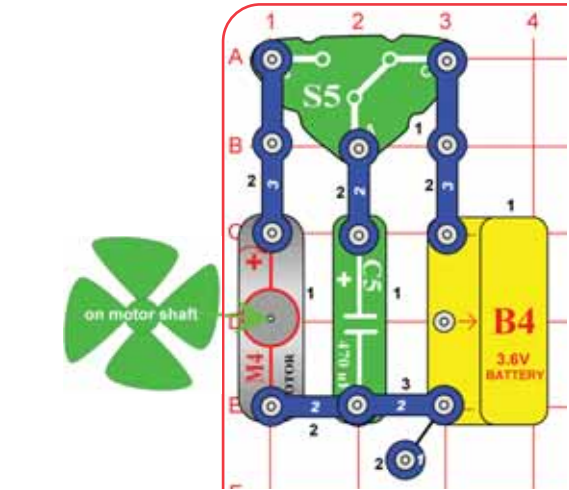

Sometimes motors under a load are difficult to get started. A capacitor can be used to give the motor a little kick. In this project setting the slide switch (S5) to the right will charge the 470µF capacitor (C5), then moving it to the left will give the motor a little kick. Since no other power is applied, the motor will not go very far on the small amount of power stored in the capacitor. This is still a good way to get a motor started as power is supplied.

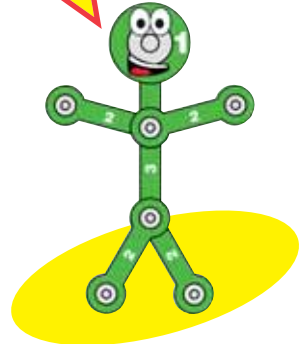



# Project #60

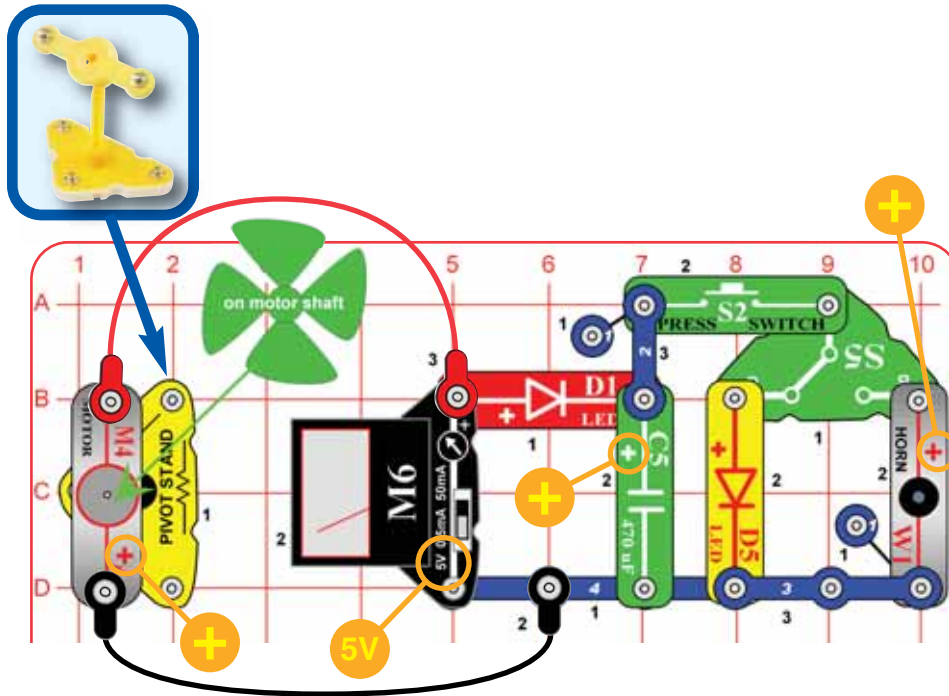

# Short Wind Power

Build the circuit shown. Set the meter to the 5V setting, and set the slide switch (S5) to position B. The meter measures how much voltage your “windmill” produces. The 470 $\mu$ F capacitor (C5) stores energy from the windmill. This project works best if get the fan spinning really fast for just a moment by blowing on it.

Capacitors can store energy but only small amounts. Rechargeable batteries are expensive, so sometimes capacitors are used when you only need a little storage.

Push the press switch (S2). Depending on the slide switch (S5) setting, either the horn (W1) makes a short sound or the yellow LED (D5) flashes as the energy stored in the capacitor discharges through it. Repeat this several times by blowing on the fan to charge up the capacitor, then pressing the switch to discharge it. If nothing happens then you need to blow harder on the fan to make a higher voltage.

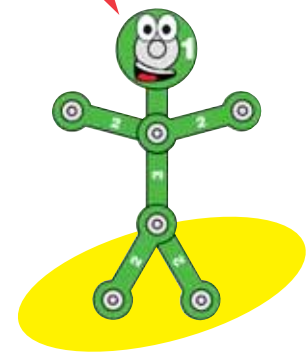

# Project #61

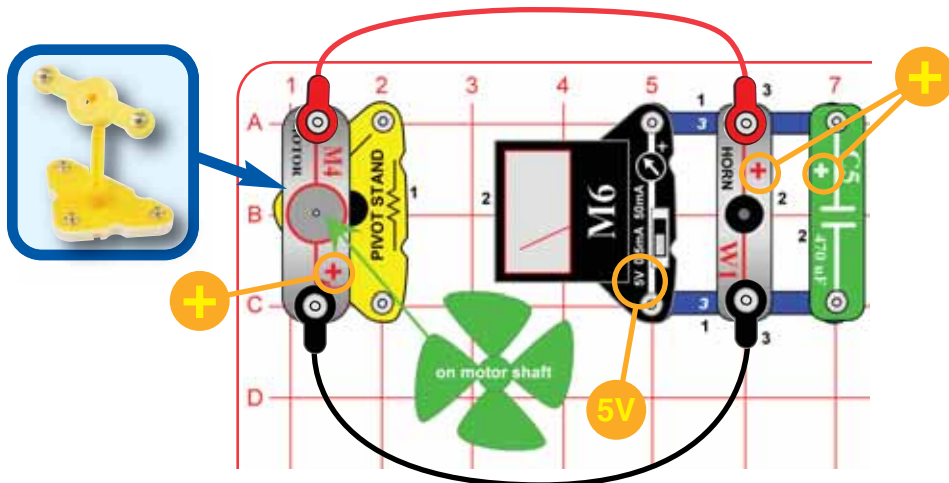

# Wind Horn

The electricity produced by the windmill motor is constantly changing, due to the mechanical design of the motor and variations in wind speed. The horn needs a steady voltage to work properly, so the 470 $\mu$ F capacitor (C5) is used. The capacitor stores a small amount of electricity and then releases it as needed to steady the voltage.

Build the circuit shown. Set the meter to the 5V setting. Blow on the fan or place it in a strong wind (either outside or near an electric fan). The meter measures how much voltage your “windmill” produces, and the horn (W1) makes noise from the voltage.

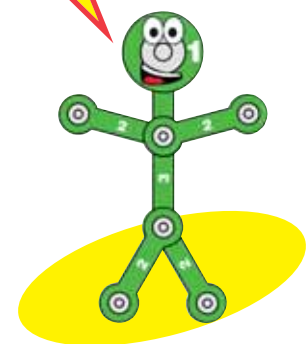



# Project #62

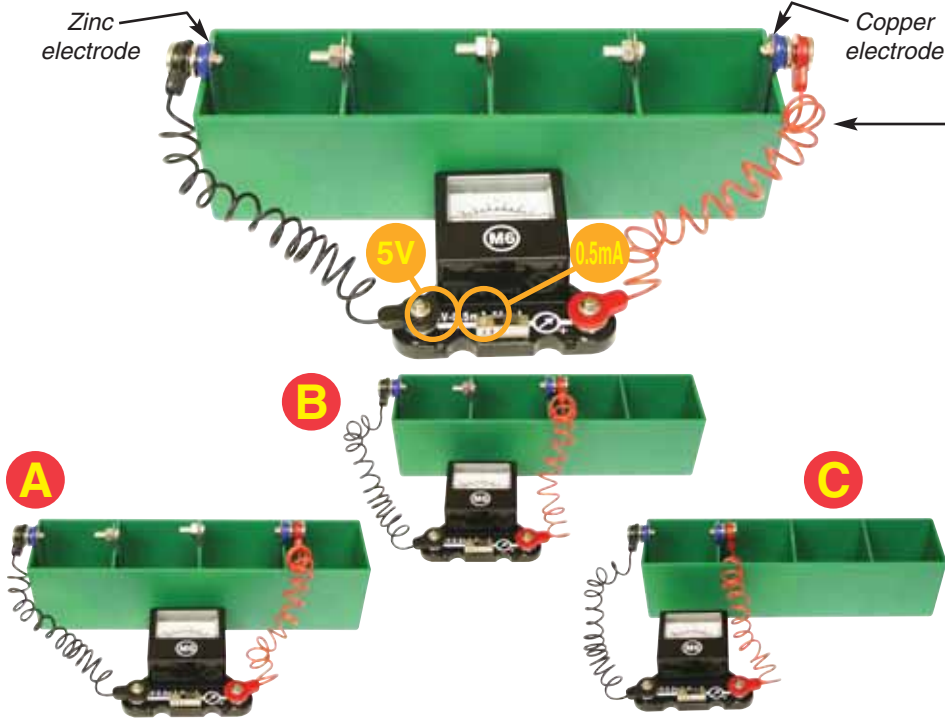

# Liquid Battery

Assemble the liquid energy source using the instructions on page 4. Connect the red & black jumper wires between the meter (M6) and the electrodes, the (+) side of the meter goes to the copper one. Set the meter to the 5V setting. Fill the compartments with cola soda (other flavors also work). The meter should show a voltage of about 3V. Switch the meter to the 0.5mA setting to measure the current produced.

Move the copper electrode with the snap on it over to the next compartment, as shown ("A"). Use the 5V setting to measure the voltage and the 0.5mA setting to measure the current. The voltage should only be about 3/4 of what it was, since you have one less compartment. The current should be about the same.

Now move the copper electrode with snap to the next compartment, so only two are used ("B") See how the voltage drops even more, but the current changes little.

Now move the copper electrode with snap to the same compartment as the electrode with snap, so you only have one cola "cell" ("C"). Measure the voltage and current now.

Don't drink any soda or juice used in this project. Wash the electrodes and liquid holder.

**Note:** Your actual results may vary. Your M6 meter is a simple meter; don't expect it to be as accurate as normal electronic test instruments.

Cola-flavored soda is lightly acidic. The acid is similar to the material used in some types of batteries but not as strong. The acid in the cola reacts with the copper and zinc electrodes to make an electric current, just like a battery. As some of the acid in the soda is used up, the current produced drops.

Each of the compartments in the liquid energy source produces about 0.75V, though the current is low. When the four compartments are connected in a series, their voltages add together to make about 3V total, but the current is the same. Each compartment is like a cell of a battery. Your B4 rechargeable battery actually contains three 1.2V "cells" in a series, just like the "cells" of the liquid energy source.

Soda can be used in this way to produce electricity, but it does not produce very much, so is not widely used. However, biomass power plants, which burn decaying food products and yard waste, are increasingly being used. These plants produce electricity from garbage that would otherwise be filling up landfills, and they don't pollute the environment.

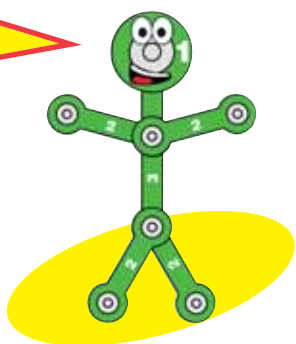

# Project #63 Juice Battery

Some fruits and vegetables have a sour taste because they are lightly acidic. This acid can be used to produce electricity just like the cola and batteries do.

Using the natural chemical energy in fruit is a very green (environmentally friendly) way to produce electricity.

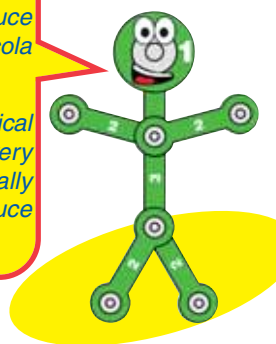

Replace the soda in the liquid energy source with fruit juice. Sour tasting juices like lemon or grapefruit work best. Measure the voltage and current for your juice battery like you did with the soda. Try different juices and compare them. Don't drink any soda or juice used in this project. Wash the electrodes and liquid holder.



# Project #64

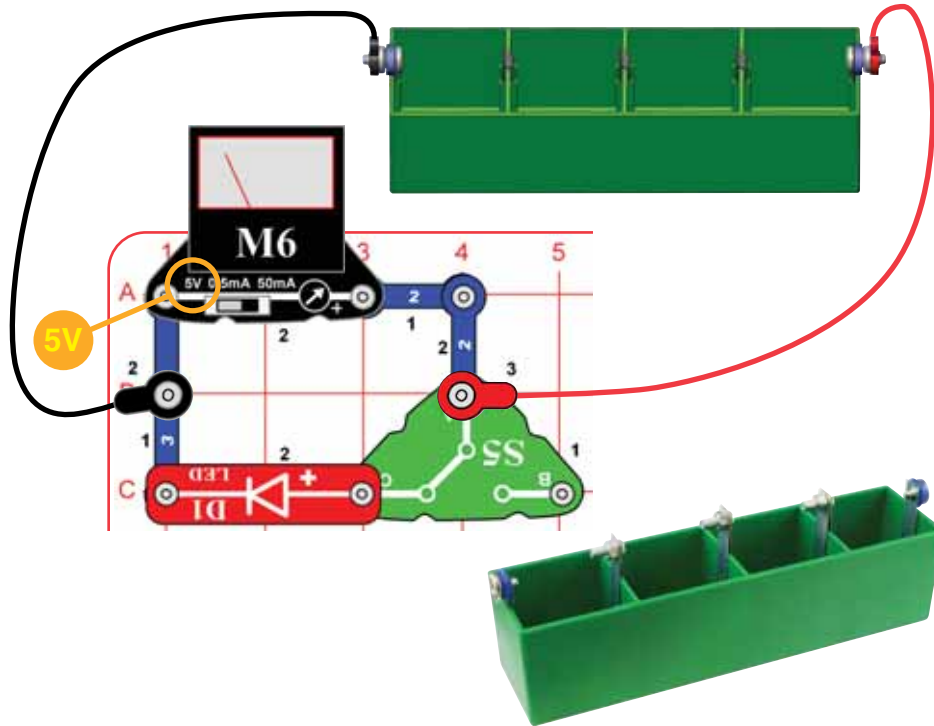

When used to measure voltage (5V setting), your M6 has a high resistance of about  $10K\Omega$ , which is placed in parallel with the voltage you are measuring. A very small amount of current will be diverted into the meter, but this will usually not have any effect on the circuit. However sometimes, if your voltage source can only produce a small amount of current, it does change the circuit operation. That is why the LED can get brighter when you remove the meter from this circuit.

When used to measure current, your M6 meter has a resistance of about  $500\Omega$  in the 0.5mA setting and about  $10\Omega$  in the 50mA setting, which is placed in the circuit so the current flows through it. This meter resistance will reduce the current it is trying to measure, but the effect will be small if the meter is set to the appropriate current scale.

Your M6 meter is a simple meter. Normal electronic test instruments can make better measurements, because they have less effect on the circuits they are measuring, but even they have limitations and they can be very expensive.

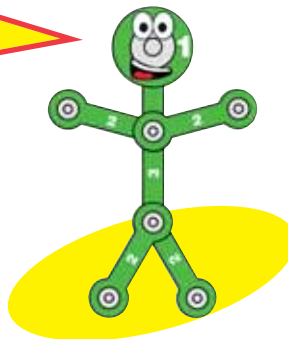

# Cola Light

Assemble the liquid energy source using the instructions on page 4. Build the circuit and connect the red & black jumper wires; the red wire goes to the copper electrode. Set the meter (M6) to the 5V setting. Fill the compartments with cola soda (other soda flavors and lemon, tomato, or grapefruit juice also work). Set the slide switch (S5) to position B. The meter shows the voltage produced.

Now set the slide switch to position C to connect the red LED (D1). The LED should be on, though it may be dim. The voltage shown on the meter may be lower now, because the cola may not be able to make as much electricity as the LED wants. If you watch the circuit for a while, the LED brightness and voltage may slowly drop as the cola reacts with the electrodes to produce electricity.

Remove the meter from the circuit. The LED may be brighter, because all the electricity produced is going to the LED now.

You can move the copper electrode with the snap on it over to the next compartment, as shown in the Liquid Battery project. The LED will be dimmer or not lit at all, because the voltage is lower.

If the copper and zinc electrodes get corroded through use, use sandpaper, steel wool, or a scraper to remove the corrosion and improve performance.

Don't drink any soda or juice used in this project. Wash the electrodes and liquid holder.



# Project #65 Yellow Cola

Replace the red LED (D1) with the yellow LED (D5). Compare the LED brightness and voltage change to the red LED in the preceding project.

The liquid energy source does not produce enough electricity to run the W1 horn or M4 motor.

The yellow LED needs a higher voltage to turn on but can get brighter.

If you had pipes pumping fresh cola into the liquid cells and removing some of the used liquid, then the LED would stay lit as long as the flow was maintained - it would be a fuel cell.

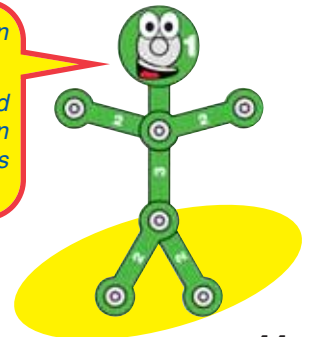



# Project #66

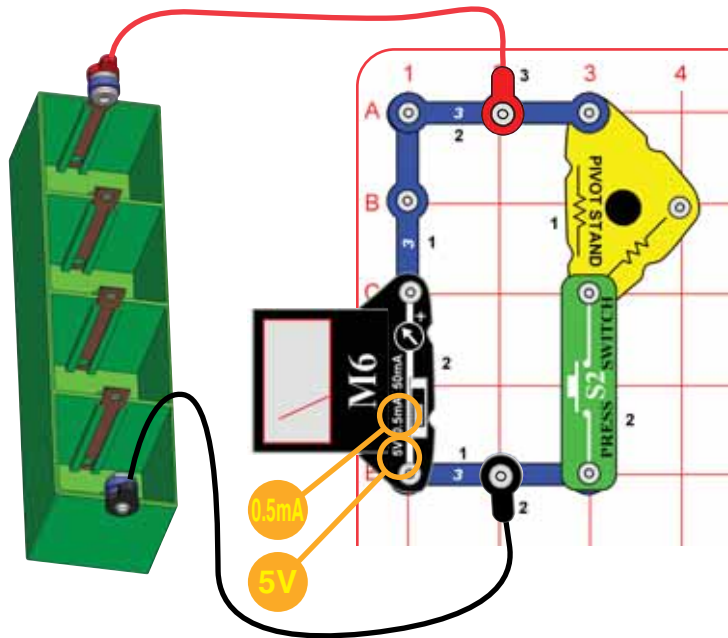

# Electricity From Water

The water in some areas is slightly acidic due to impurities in it. This may be strong enough to produce electricity by reacting with the electrodes, similar to how a battery works. These impurities should be safe to drink. Distilled water has almost no impurities.

Assemble the liquid energy source using the instructions on page 4. Build the circuit and connect the red & black jumper wires; the red wire goes to the copper electrode. Set the meter (M6) to the 5V setting. Fill the compartments with water. The meter shows the voltage produced, if any.

Set the meter to the 0.5mA setting to see how much current your water can supply, if any. If the reading is higher than 0.5mA, push the press switch to change the current scale to 5mA. (The switch adds a 47Ω resistor in the pivot stand to the circuit, changing the current scale on the meter. It should not be used with the 5V setting.)

Try dissolving some salt in the water in all four compartments. The voltage and current should be higher now. If you have some distilled water, test it too (rinse out the salt water first). The voltage and current produced should be zero now.

Don't drink any water used in this project. Wash the electrodes and liquid holder.

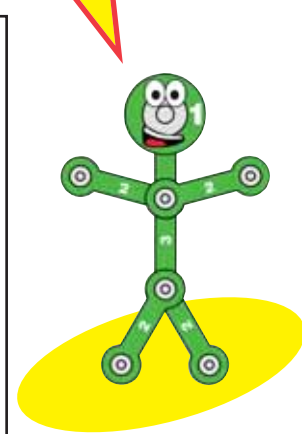

# Project #67

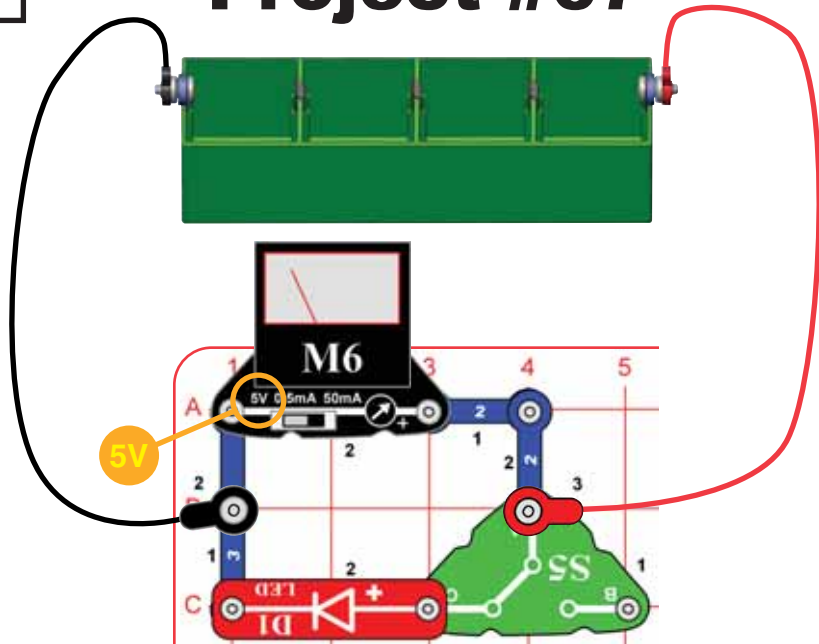

# Water Light

Connect the liquid energy source to the circuit shown here. Fill the compartments with water. Set the slide switch (S5) to position C. Set the meter to the 5V setting to see the voltage produced. The red LED (D1) may be dimly lit, depending on your local water supply. If you set the switch to position B, the voltage may be higher since the water is not trying to light the LED.

Dissolve some salt in the water in all four compartments. The voltage will be higher and the LED should light now. See how long it lights the LED for.

Try replacing the red LED with the yellow LED (D5) or the clock (T2). See how long the water can run the clock. If you would like to set the time, see page 4.

Salt and other impurities in the water react with the electrodes to produce electricity like the cola does in project 64. The voltage produced by the water is usually lower and water will not run the LED or clock as long.

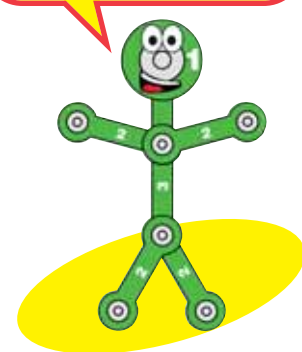



# Project #68

# Cola Clock

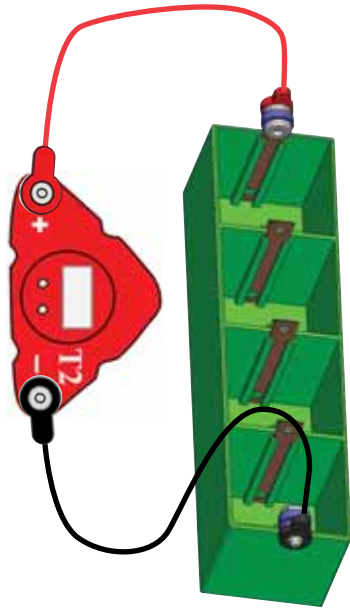

### Setting the time on the clock (T2):

- Press the left button to select what to change (month, date, hour, or minutes).
- Press the right button until it is correct.
- Press the left button until the time is showing, then press the right button once to start.
- The colon (":") will be flashing when the clock is running.
- Press the right button to display the date.

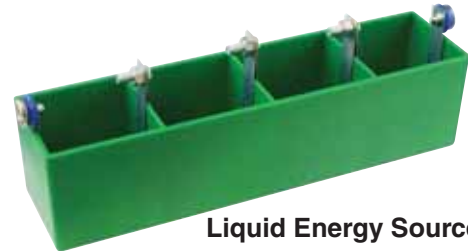

Liquid Energy Source

The clock needs very little electric current to operate (much less than 1mA). The liquid power source does not produce much electricity, but it can supply enough for the clock. Slowly, the chemical energy in the cola is used up, and the voltage drops enough for the clock to stop working.

Assemble the liquid energy source using the instructions on page 4. Connect it to the clock (T2) with the red & black jumper wires, the red wire goes to the copper electrode. Fill the compartments with cola soda (other soda flavors and lemon, tomato, or grapefruit juice also work). The clock should be running. Set the time if you like.

With cola, the clock will typically run for a week. When the display gets dim, replace the cola.

You can move the copper electrode with the snap on it over to the next compartment, as shown in the Liquid Battery project. The clock display will not be as bright now.

If the copper and zinc electrodes get corroded through use, use sandpaper, steel wool, or a scraper to remove the corrosion and improve performance.

Don't drink any soda or juice used in this project. Wash the electrodes and liquid holder.

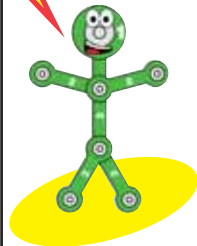

# Project #69

# Cola Clock with Memory

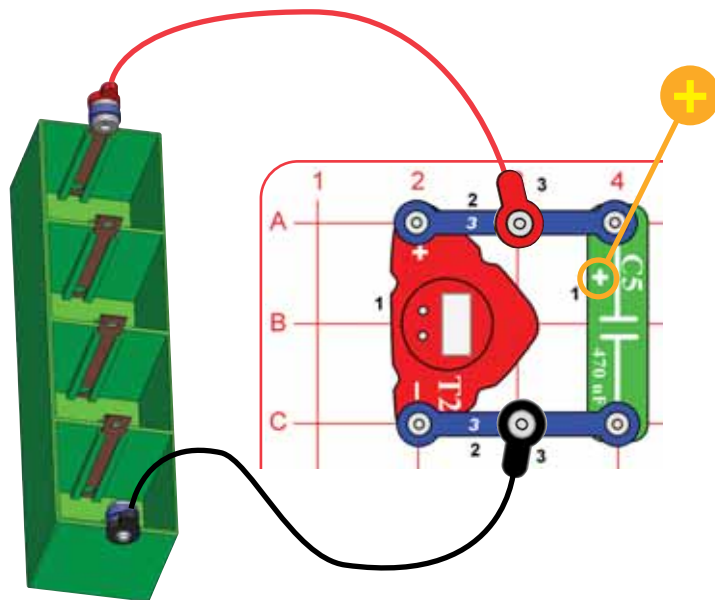

You could also use a battery for electricity storage instead of the capacitor. A battery stores much more electricity than a capacitor but you don't need much storage here. Batteries are much more expensive than capacitors and contain chemicals that can harm the environment when you throw them away.

In the preceding Cola Clock project, when you disconnect the liquid energy source to replace the cola, the time is lost. Wouldn't it be nice if the clock remembered the time long enough for you to replace the cola?

Add the 470µF capacitor to the clock as shown here. The capacitor stores enough electricity to run the clock for a while if you disconnect the liquid energy source.

Don't drink any soda or juice used in this project. Wash the electrodes and liquid holder.

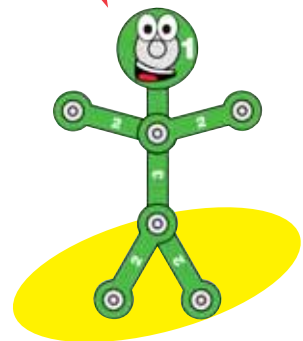



# Project #70

# Changing Water Pressure to Electrical Pressure

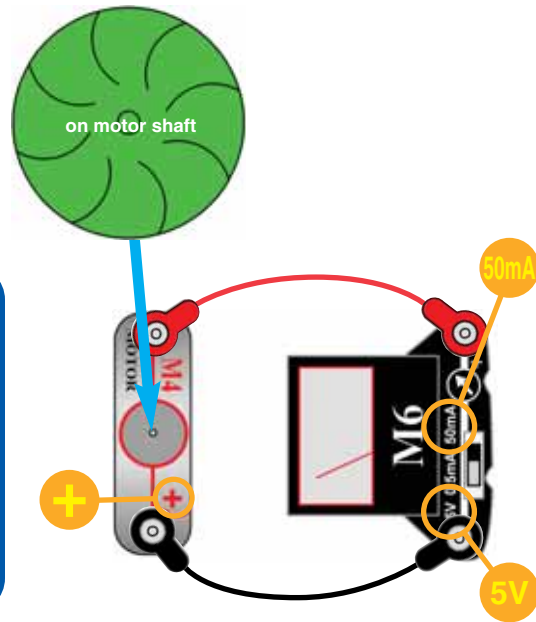

Place the water wheel on the motor (M4) and connect it to the meter (M6), as shown. Set the meter to the 5V or 50mA setting. Hold the motor under a water faucet so the water wheel will “catch” the water as it falls. See how much voltage and current you can produce.

Using the water pressure from your faucet to make electricity using the motor (used as a generator here) is just like using water pressure from a lake to run an electric generator in a dam.

Your parts might stop working if water gets inside them. Let them dry out and they should be fine.

Hoover Dam has a lake that is 500 feet deep on one side to provide great pressure to turn the generators that make our electricity.

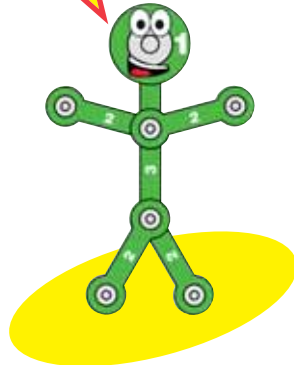

# Project #71

# FM Radio

See projects 1 & 3 if you need to recharge the battery (B4).

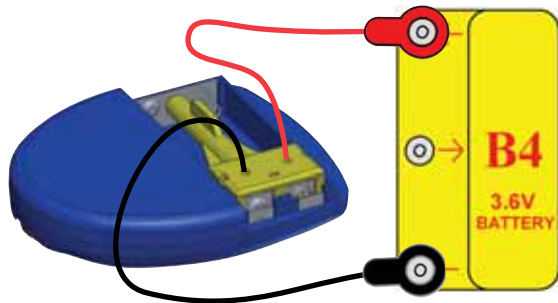

## INSTALLING BATTERY ELIMINATOR

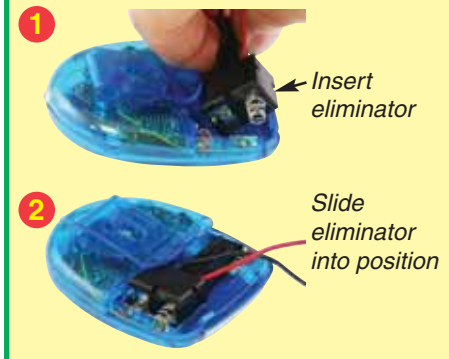

Install the battery eliminator connector into the battery compartment in the FM radio, as shown. Connect the red and black snap wires to the battery (B4). Plug the earphones into the radio and place the earphones in your ears. Turn the volume knob clockwise to turn on the radio, press the reset button, then press the scan button several times to find a radio station (radio features may vary).

Listen to the radio for a while. If the sound is distorted, then recharge the battery using the solar cell or other power sources in this kit.

With Snap Circuits® Green, you can run your radio with the limitless and clean power from the solar cell, using the battery as a storage device. Your radio can also be used with normal “AAA” type batteries, but these would need to be replaced regularly.

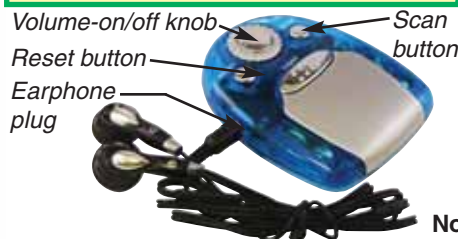

Radio is sending messages through the air using high frequency electromagnetic waves. It is like yelling to someone far away, but uses very fast changes in electric/magnetic fields instead of slow changes in air pressure and using a tone that only someone tuned to it can hear.

Note: Radio style and features may vary.

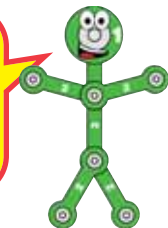





# Project #72

# Hydro Lights



See projects 1 & 3 if you need to recharge the battery (B4).

Place the water wheel on the motor (M4) and connect it to the circuit as shown. Hold the motor under a water faucet so the water wheel will "catch" the water as it falls. The LEDs (D1 & D5) should light.  
Your parts might stop working if water gets inside them. Let them dry out and they should be fine.

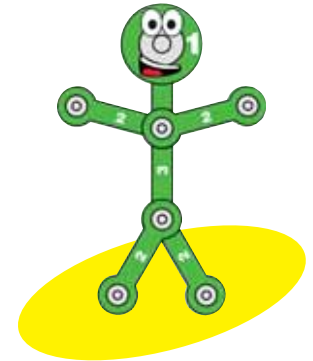
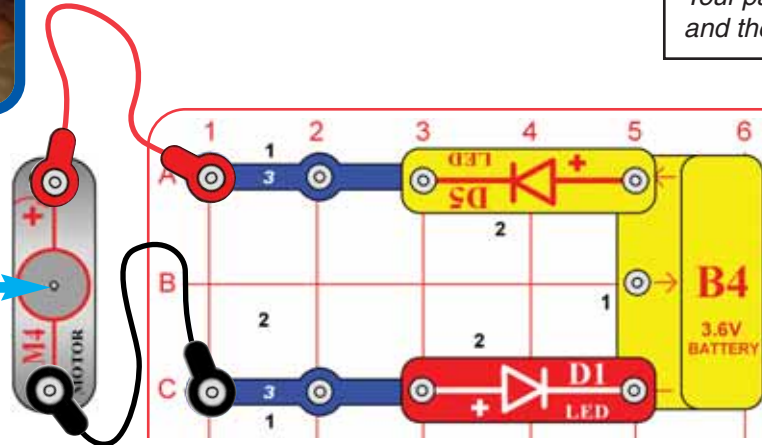

# Project #73

# Directional Wind Lights

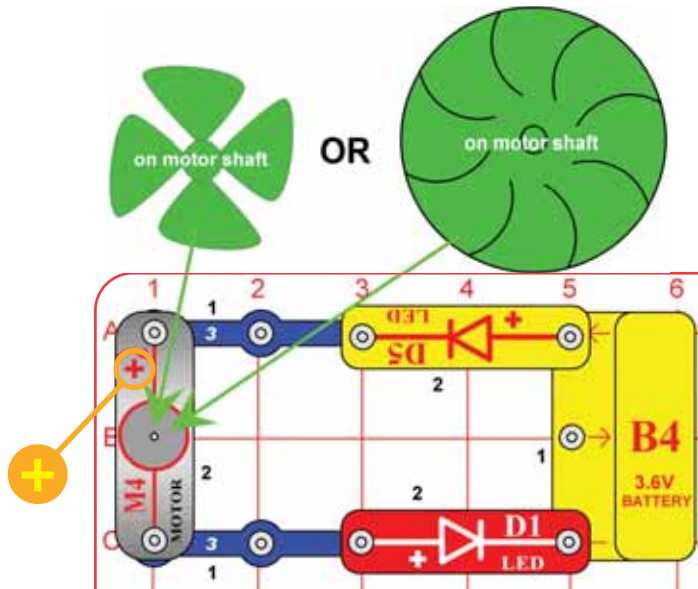

Build the circuit, and place either the wind fan or the water wheel on the motor (M4). To make the LEDs (D1 & D5) bright, blow on the wind fan from above, or blow into the "curves" of the water wheel.

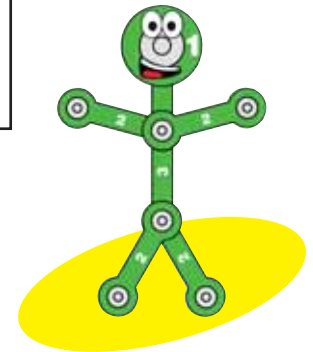



# Project #74

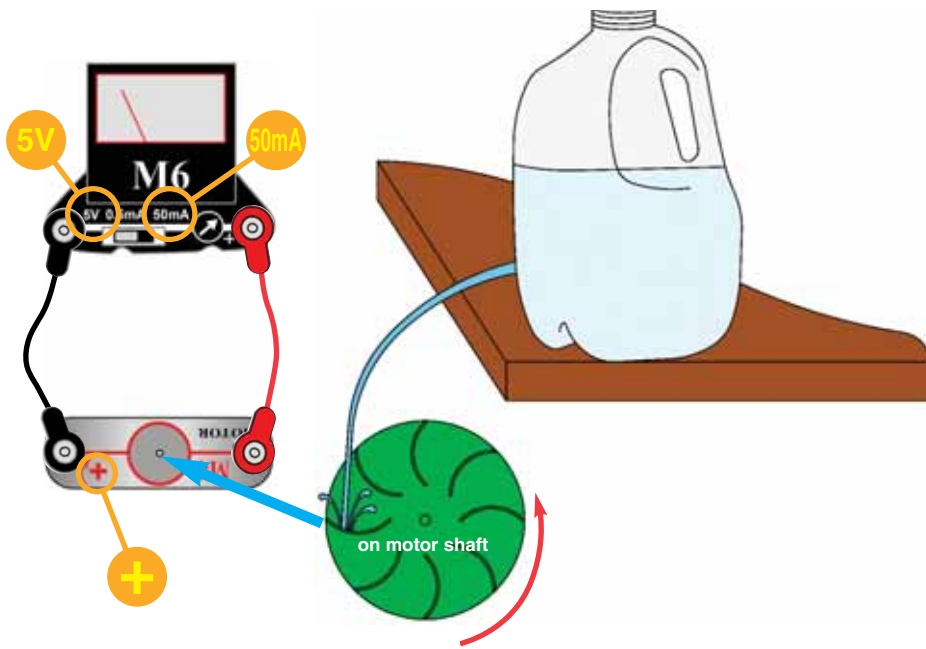

# Using Stored Water

Place the water wheel on the motor (M4) and connect it to the meter (M6), as shown. Set the meter (M6) to the 5V or 50mA setting. Take an empty plastic water or milk container, make a hole about 3 inches from the bottom, place the bottle in a sink or bathtub, fill it with water, and then hold the water wheel next to it and measure the voltage or current produced.

Fill the container to different heights and see how the water pressure affects the meter measurement. Plug the hole with your finger while you fill the container, and try to keep the water wheel in the same position each time.

Your parts might stop working if water gets inside them. Let them dry out and they should be fine.

Raising the water level in the container is just like storing water in a lake next to a dam. A higher water level means more water pressure, which spins the shaft faster, which produces more electricity.

A dam converts the potential energy of the high water into kinetic energy of fast moving water, which is reduced when the water is used to spin the turbine in a generator. The water in Hoover Dam is 500 feet deep at its base and reaches speeds of 85 mph going into the turbine.

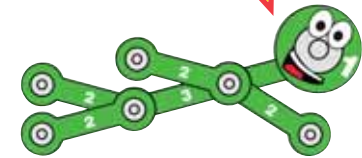

## Generator

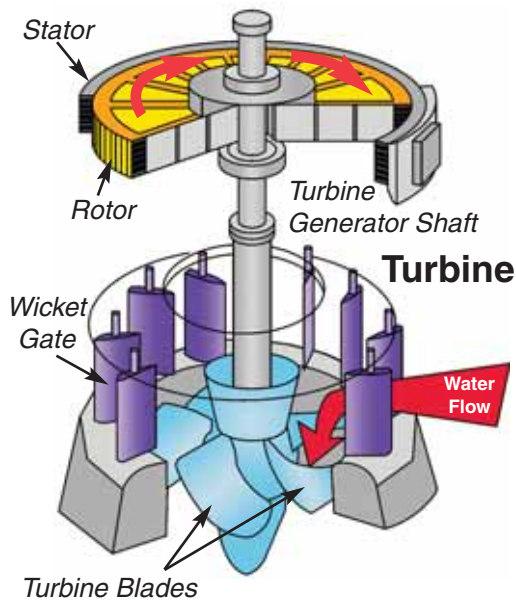

# Project #75 Water Redirection

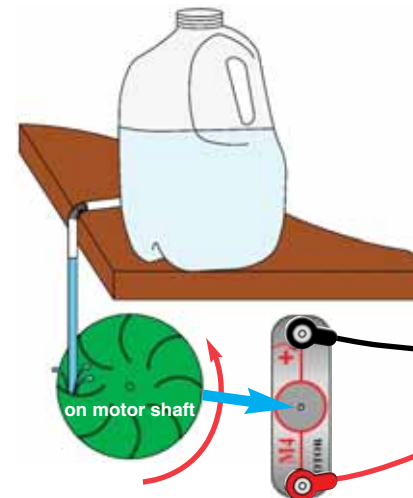

In dam generators, the water to the turbine blades is directed by a series of wicket gates.

Attach a straw (flexible ones work best) from your home to redirect the flow to the Water fan. Try and seal the area around the straw with putty, play dough, scotch tape or other such material. Repeat the meter readings from the previous project and see how much the power has increased.



## Project #76

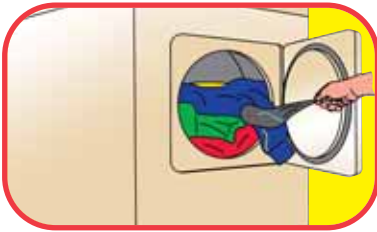

Find some clothes that cling together in the dryer, and try to uncling them.



The crackling noise you hear when taking off a sweater is static electricity. You may see sparks when taking one off in a dark room.



Rub a sweater (wool is best) and see how it clings to other clothes.

**Note:** This project works best on a cold dry day. If the weather is humid, the water vapor in the air allows the static electric charge to dissipate, and this project may not work.

## One of the Most Powerful Forces in the Universe

These effects are caused by electricity. We call this static electricity because the electrical charges are not moving, although pulling clothes apart sounds like static on a radio. When electricity is moving (usually through wires) to do something in another place, we call it an electric current.

Electricity exists everywhere but is so well balanced that you seldom notice it. But sometimes, electrical charges get separated and build up a difference between materials, and sparks can fly. Lightning is the same effect as the sparks between clothes, but on a much greater scale. A cloud holds static electricity just like a sweater.

The static electricity around us is extremely powerful. If we could learn to move and control it, we might have all the energy we need. Maybe someday you will find a way.

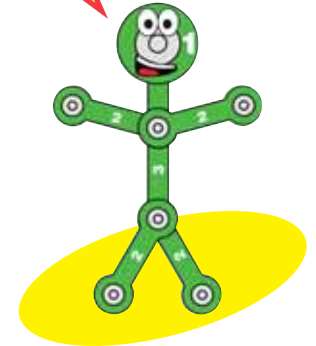

## Project #77



**Note:** This project works best on a cold dry day. If the weather is humid, the water vapor in the air allows the static electric charge to dissipate, and this project may not work.

## Electricity Against Water

You need a comb (or plastic ruler) and a water faucet for this project. Run the comb through your hair several times then hold it next to a slow, thin stream of water from a faucet; the water will bend towards it. You can also use a plastic ruler. Rub it on your clothes (wool works best).

Rubbing the comb through your hair builds up a static electrical charge on it, which attracts the water.

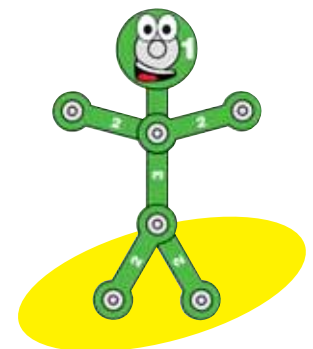



# Project #78

# Harnessing Static Electricity

You need a comb (or a plastic ruler) and some paper for this project. Rip up the paper into small pieces. Run the comb through your hair several times then hold it near the paper pieces to pick them up. You can also use a plastic ruler, rub it on your clothes (wool works best).

Rubbing the comb through your hair pulls extremely tiny charged particles from your hair onto the comb. These give the comb a static electrical charge, which attracts the paper pieces.



If you have two balloons, rub them to a sweater and then hang the rubbed sides next to each other. They repel away. You could also use the balloons to pick up tiny pieces of paper.



Take a piece of newspaper or other thin paper and rub it vigorously with a sweater or pencil. It will stick to a wall.



Cut the paper into two long strips, rub them, then hang them next to each other. See if they attract or repel each other.

Get a roll of plastic tape. Make some strips about a foot long. Hold their ends so they hang downwards, and slowly bring them close together. See if you can make them touch each other.

Electricity is immensely more powerful than gravity (gravity is what causes things to fall to the ground when you drop them). However electrical attraction is so completely balanced out that you don't notice it, while gravity effects are always apparent because they are not balanced out.

Gravity is actually the attraction between objects due to their weight (or technically, their mass). This effect is extremely small and can be ignored unless one of the objects is as big as a planet (like the earth). Gravity attraction never goes away and is seen every time you drop something. Electrical charge, though usually balanced out perfectly, can move around and change quickly.

For example, you have seen how clothes can cling together in the dryer due to static electricity. There is also a gravity attraction between the sweaters, but it is always extremely small.

Some electricity is produced in dams, by harnessing the power of gravity to move water to spin a generator. If instead we could harness the static electricity contained in the water, we would have all the electricity we need.

**Note:** This project works best on a cold dry day. If the weather is humid, the water vapor in the air allows the static electric charge to dissipate, and this project may not work.

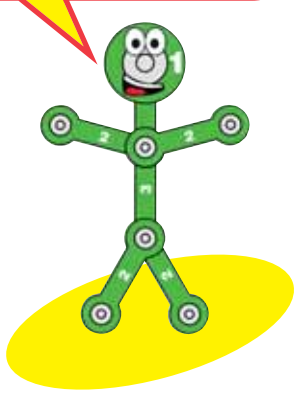

Snappy says to notice how your hair can "stand up" or be attracted to the comb when the air is dry. Wetting your hair dissipates the static charge.

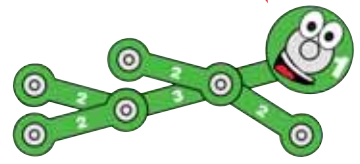



# Project #79

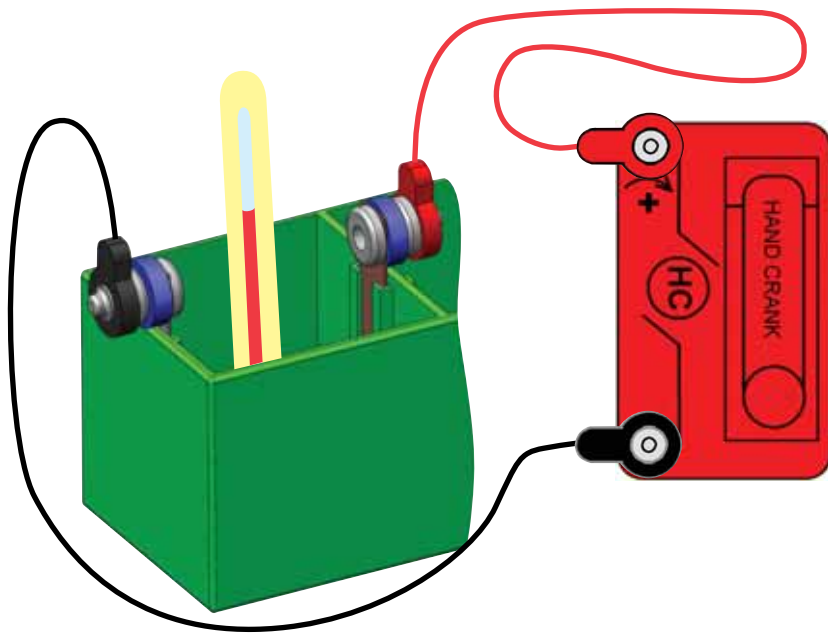

# Storing Energy in Water

Place ½ teaspoon of salt into a small amount of water and stir until it dissolves. You can use a compartment on the liquid power source for this, but don't use a metal container. If available, use a thermometer from your home to measure the water temperature. If no thermometer is available, test the water temperature by touching it with your finger. Connect the red & black jumper wires to the hand crank (HC) and place the loose ends in the water so they aren't touching.

Turn the crank to heat the water. You should see the temperature rise on the thermometer or feel the difference with your finger. You may have to crank for a minute or two before the water gets warmer.

Solar or wind power may be used to heat water during the day, then use the hot water to keep homes warm at night.

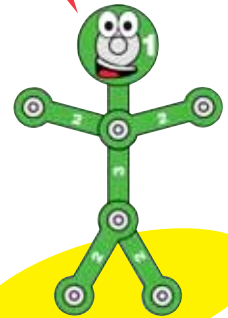

# Project #80

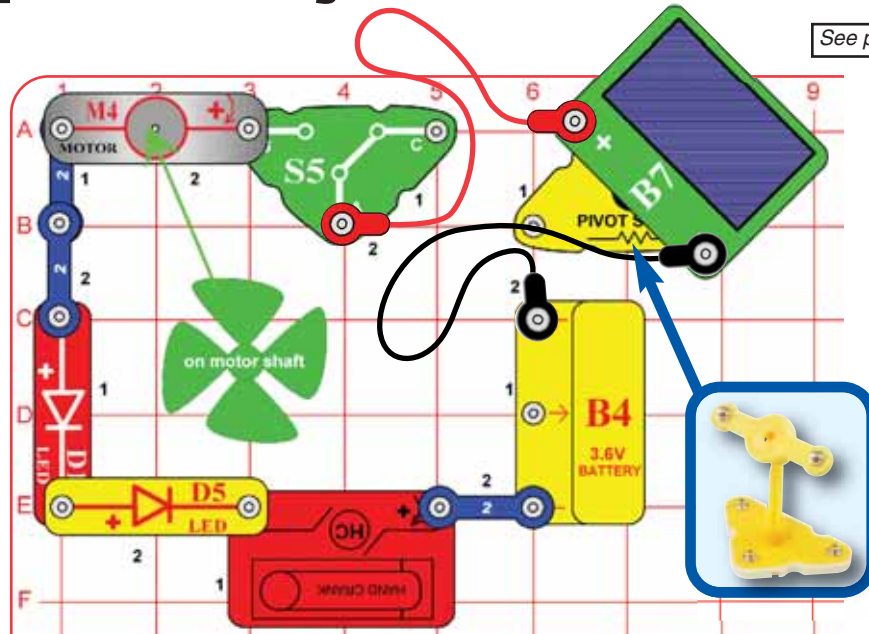

See projects 1 & 3 if you need to recharge the battery (B4).

This circuit combines several power sources to run several devices in series. Build the circuit as shown, and place the solar cell (B7) in sunlight or near an incandescent lamp. Set the switch (S5) to position B. If your light is bright enough, the LEDs may be dimly lit and the fan may spin if you give it a push to get started.

Now turn the hand crank clockwise to make more power. The LEDs should be brighter and the fan should spin faster.

It takes a lot of voltage to run both LEDs and the motor when they are connected in series, but combining the battery, solar cell, and hand crank gives you enough.

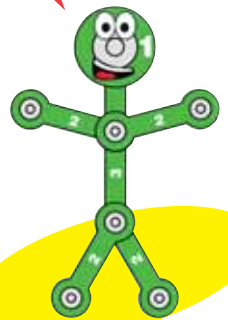

# Project #81

# Solar Light Clock

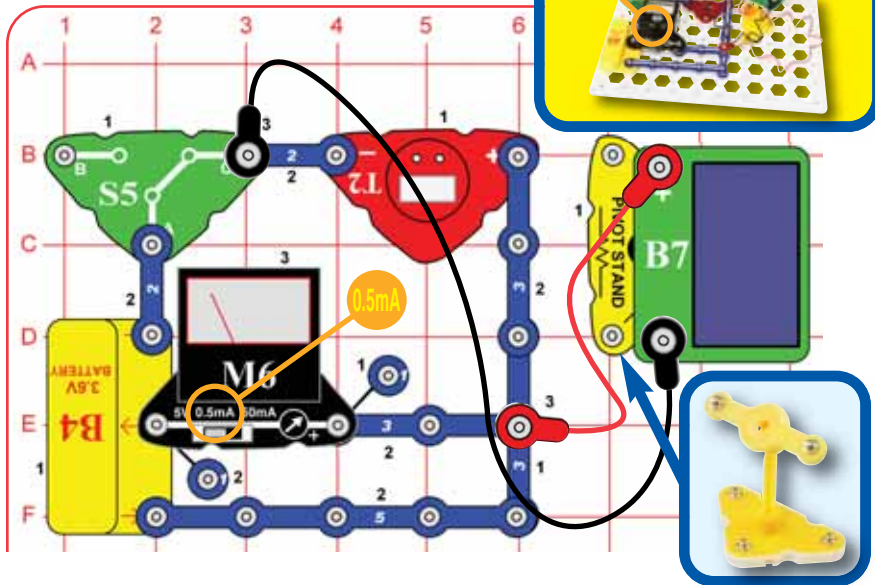

Assemble the pivot, mount the solar cell (B7) on it, and place it next to the circuit as shown. Connect the solar cell to the circuit using the red and black jumper wires. Set the meter to the 0.5mA setting. Set the slide switch (S5) to position B. Place the circuit so the solar cell is in bright sunlight or close to an incandescent light bulb. The display on the clock (T2) should be on.

Now set the slide switch to position C, to add the rechargeable battery to the circuit. See if you can adjust the position of the solar cell on the pivot to make the meter (M6) measure a current.

If your light source is strong enough then the solar cell will charge the battery while running the clock. If your light source is weak then the battery will run the clock.

If you would like to set the time on the clock, see page 4.

Solar cells are often used with rechargeable batteries, since the sun isn't always shining. Used together, the solar cell and battery can run the clock for a very long time.

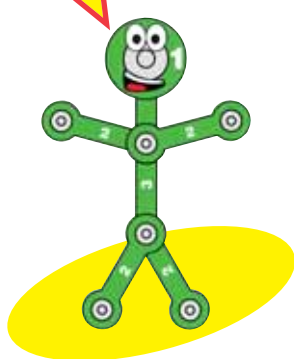

# Project #82

# Solar Light Charger

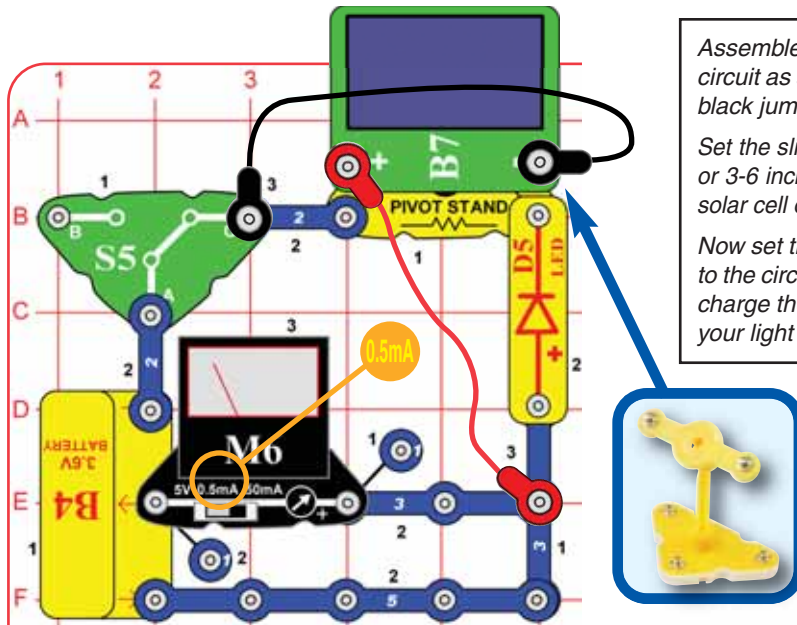

Assemble the pivot, mount the solar cell (B7) on it, and place it in the circuit as shown. Connect the solar cell to the circuit using the red and black jumper wires. Set the meter to the 0.5mA setting.

Set the slide switch (S5) to position B. Place the circuit in bright sunlight or 3-6 inches from an incandescent light bulb. Adjust the position of the solar cell on the pivot to make the yellow LED (D5) brightest.

Now set the slide switch to position C, to add the rechargeable battery to the circuit. If your light source is strong enough then the solar cell will charge the battery, and the meter will measure the charging current. If your light source is weak then the battery will light the yellow LED.

The solar cell only produces a small amount of electricity. The yellow LED needs a lot more electricity than the clock, so the solar cell can only run the LED and charge the battery if the light source is very strong.

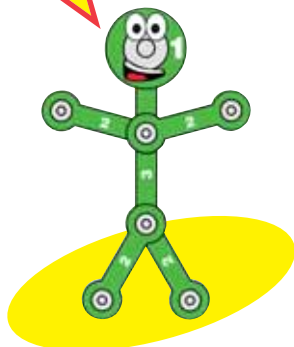
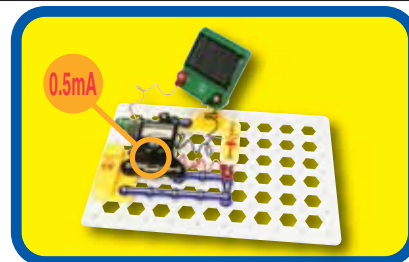



# Project #83

# Solar Lights Row

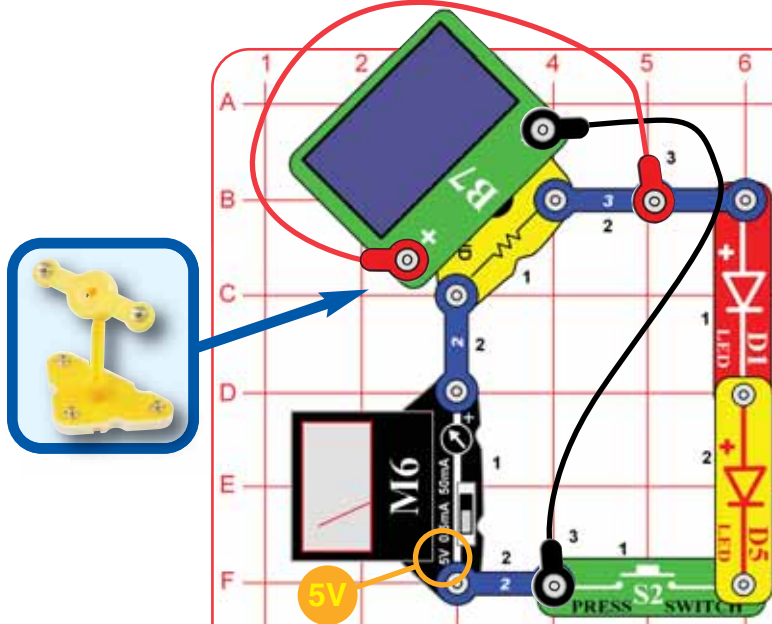

Assemble the pivot, mount the solar cell (B7) on it, and place it in the circuit as shown. Connect the solar cell to the circuit using the red and black jumper wires. Place the circuit so the solar cell is in bright sunlight or close to an incandescent light bulb. Set the meter (M6) to the 5V setting.

The meter is measuring the voltage produced by the solar cell. Adjust the position of the solar cell to make the highest voltage you can. Now push the press switch to run the red and white LEDs (D1, D5) with the solar cell. Notice how the voltage produced drops a little when the LEDs are connected, but not as much as when only the yellow LED was in the circuit (the Solar Power project).

**Note:** The voltage produced is actually twice that shown on the meter (so a 3V reading is really 6V), because a resistor in the pivot stand is changing the scale.

Having both LEDs in series resists the flow of electric current more than just one, making it easier for the solar cell to run them.

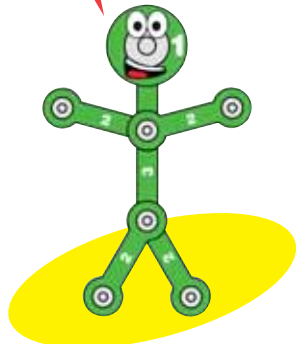

# Project #84

# Crank Support

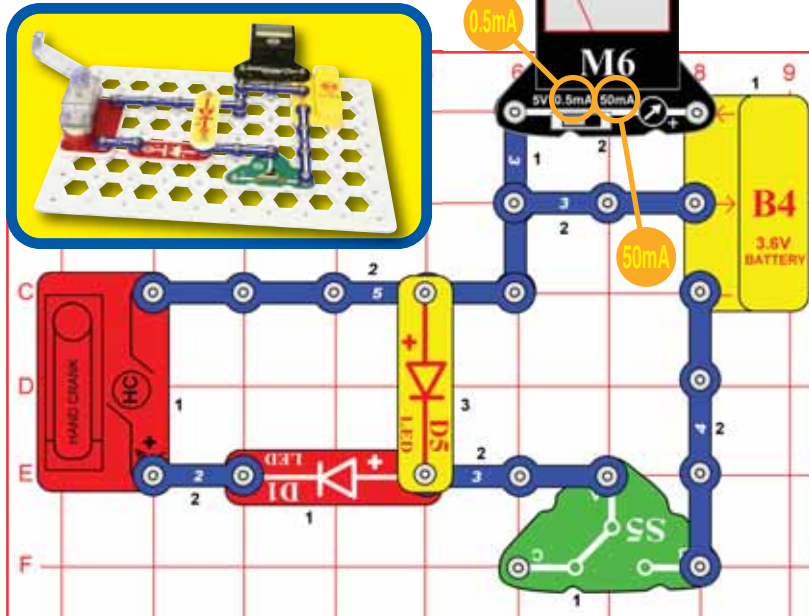

Build the circuit by setting up the parts as shown. Be sure to place the parts with their (+) side oriented as shown. Set the meter (M6) to the 0.5mA or 50mA setting. Set the slide switch (S5) to position B to connect the rechargeable battery (B4) to the yellow LED (D5). If the battery is charged, the LED will light and the meter will show that an electric current is flowing out of the battery. The 0.5mA meter scale will show a high current while the 50mA scale may show little or no current.

Turn the handle on the hand crank (HC) counter-clockwise (opposite to the direction a clock turns) to have it take over powering the yellow LED. When you crank fast enough, the red LED (D1) will turn on and the meter will no longer show any current flowing.

**Warning:** the hand crank is sturdy but not indestructible. If you push hard on it or crank it really fast you may break it.

Think of the yellow LED as an emergency light in your home. When the main power goes out, it can run for a while on battery backup or a hand crank generator.

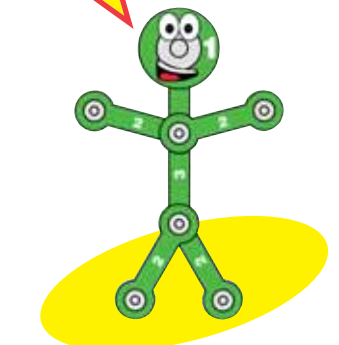



# Project #85

# Crank Charging

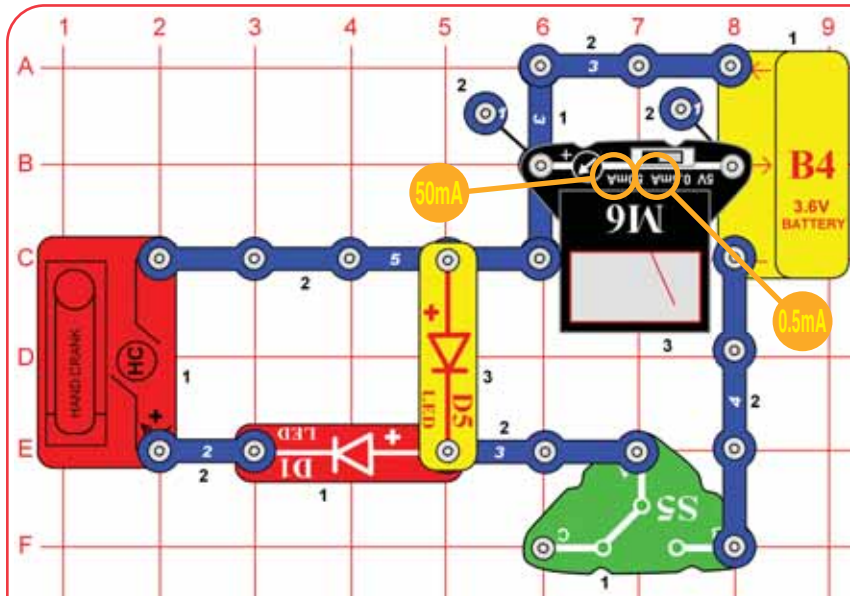

In the preceding circuit, when the hand crank is powering the yellow LED it is also charging the rechargeable battery. Change the circuit to be the one shown here so you can measure the charging current. Note that two single snaps are placed beneath the meter.

The circuit works the same way, except that now the meter shows when electric current generated by the hand crank is flowing into the battery. You can use either the 0.5mA or 50mA meter setting.

If you set the slide switch to position C, the battery is disconnected and only the hand crank will run the LED.

Turning the crank recharges the battery, so the LED will stay on much longer!

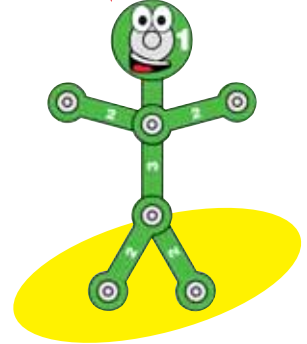

# Project #86

# Crank Sound

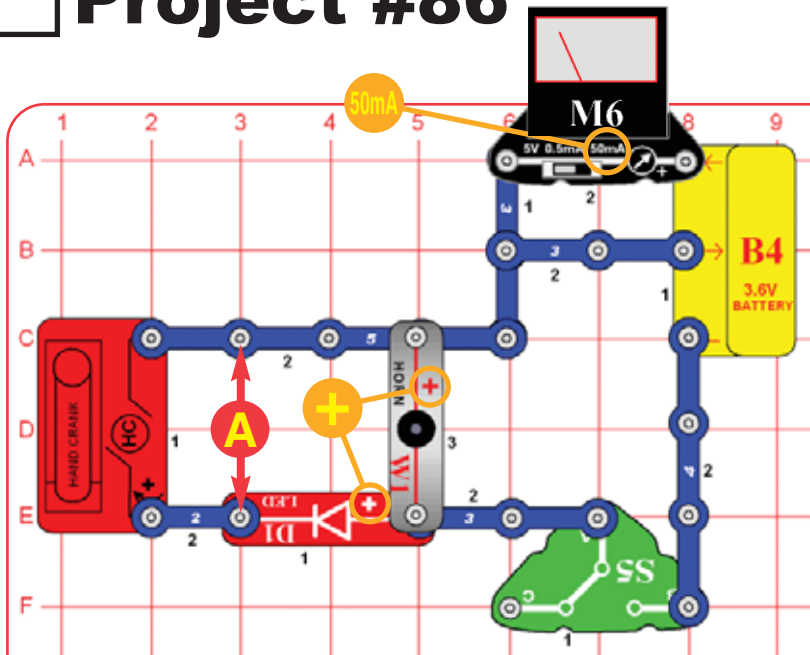

Modify the preceding circuit to be the one shown here. Set the meter (M6) to the 50mA setting. Set the slide switch (S5) to position B to connect the rechargeable battery (B4) to the horn (W1). The meter (M6) measures the current.

Now set the switch to position C to disconnect the battery, and turn the handle on the hand crank counter-clockwise to power the horn. Notice that the horn sound is not as clear as when the battery powered it.

Add the 470µF capacitor (C5) across point A, base grid locations C3 to E3 ("+" on top). Now the sound with the hand crank is clearer and louder.



The electricity produced by the chemical reaction in the battery is more stable than that produced by the generator in the hand crank. The capacitor filters the electricity so the hand crank makes the sound as good as the battery.

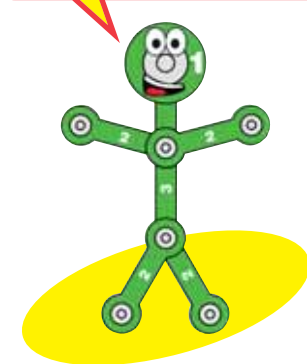





# Project #87

# Hand Lights

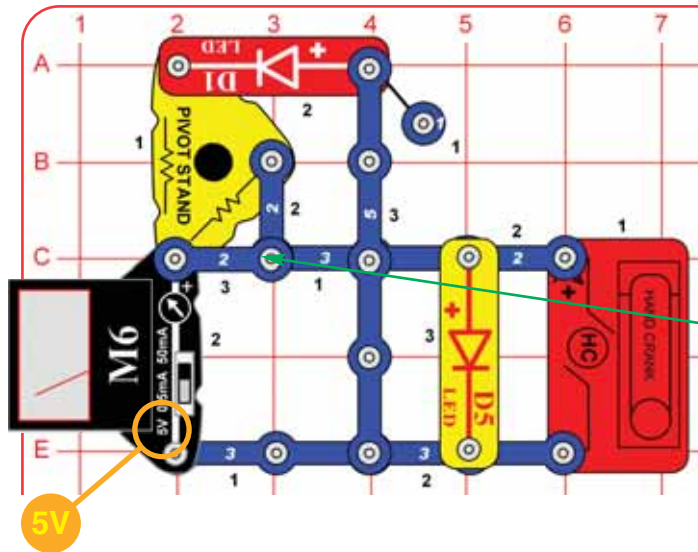

Set the meter (M6) to the 5V setting and turn the hand crank (HC). Turning clockwise will light the yellow LED (D4) while the meter shows the voltage produced. Turning counter-clockwise produces electricity flow in the opposite direction, so the red LED (D1, pointing the other way) lights.

You can probably turn the crank fast enough to measure more than 5V on the meter. Remove the 2-snap wire across base grid locations C2-C3 on level 3. This puts a 10KΩ resistor in the pivot stand in series with the meter, changing its voltage scale. Now turn the hand crank but double the voltage shown on the meter (so 4V is really 8V).

The hand crank has a gearbox, which allows a motor in it to spin faster and with less force than you turn the crank. The faster the motor spins, the more electricity is produced.

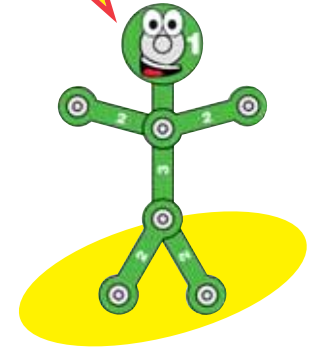

# Project #88

# Hand Noise

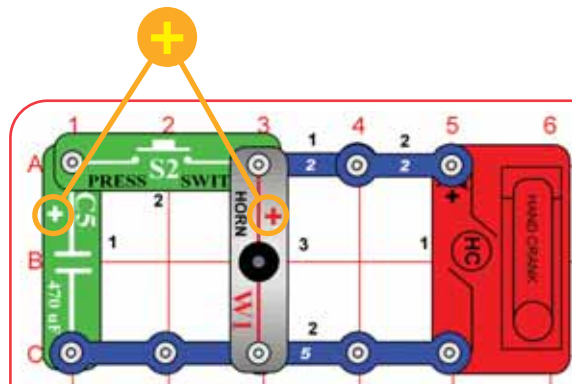

Turn the hand crank (HC) clockwise. The horn (W1) makes noise. Push the press switch (S2) at the same time to make the sound louder.

If you are out in the wilderness, you can use a hand crank and horn to sound an alarm.

The electricity produced by the hand crank is unstable, due to the design of the motor inside it and because you can't turn the crank in a steady manner. The 470μF capacitor (C5) acts like a filter to stabilize the electricity, which makes the horn work better.

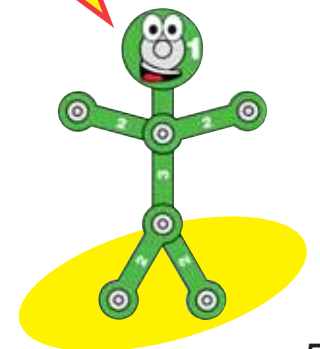



# Project #89

# Heavy Fan

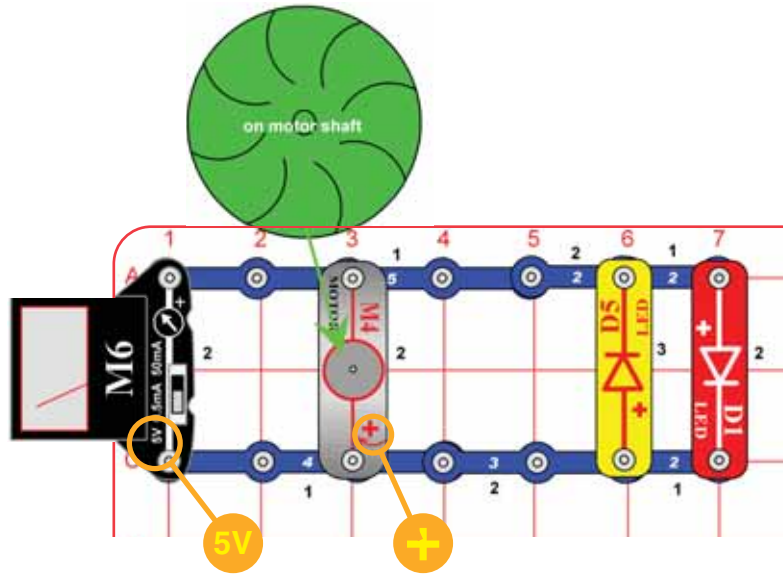

Build the circuit as shown, with the water wheel on the motor. Set the meter (M6) to the 5V setting. Blow on the water wheel, aiming the air into the "curves" on the fan. Watch the meter to see the voltage produced, and the red LED (D1).

If you blow on the opposite side of the fan curves, the fan will not spin as easily. The yellow LED (D5) will light if you blow hard enough.

The water wheel was made to use with water, but wind can push it too.

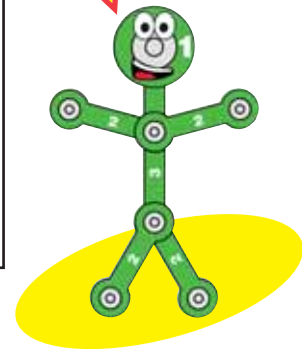

# Project #90

# Remote Heater

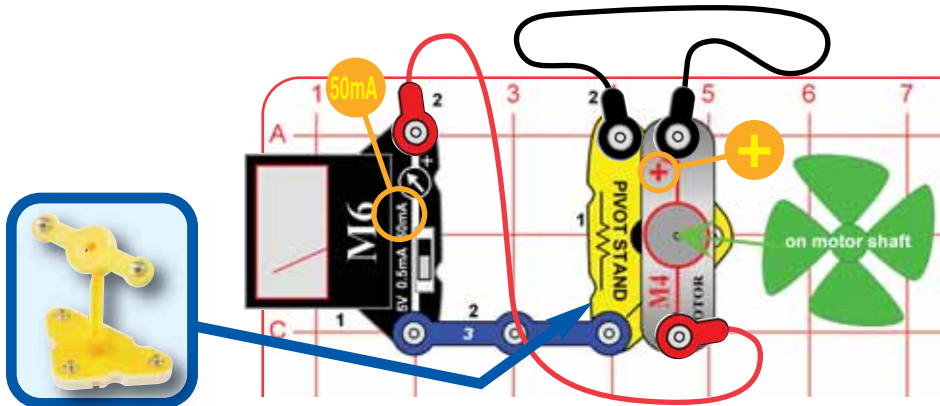

Build the circuit as shown, with the motor (M6) on the pivot and the wind fan on the motor. Set the meter (M6) to the 50mA setting. Blow on the fan or place it in a strong wind.

This circuit uses wind power to heat a 47Ω resistor in the pivot stand. The resistor is getting warmer, but you will not notice it through the plastic case. The meter measures the current.

You can replace the motor with the solar cell (B7, red wire to "+" side) to heat the resistor using sunlight.

Most of the energy used to make electricity eventually becomes heat. Many computers and TVs have fans to circulate the air to prevent components from overheating. LEDs convert some of the electricity to light, and the rest becomes heat. The radio and horn convert some electricity to sound waves, and the rest becomes heat.

You can help to heat your home by putting a windmill on your roof and using it to heat a resistor in your living room.

Electricity is great for transporting energy. Here electricity is used to move energy harnessed from the wind to the resistor where it is used. The electrical transmission lines in your neighborhood transport the electricity from a power plant to your home.

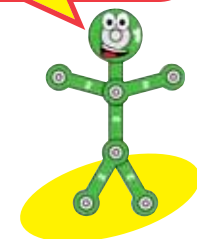



# Project #91

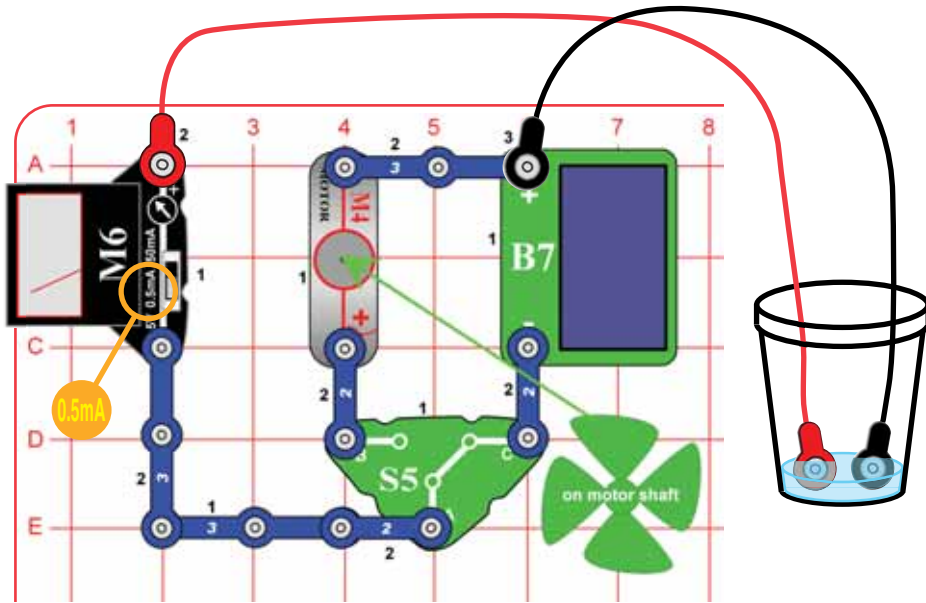

# Remote Water Heater

Build the circuit, place the wind fan on the motor (M4), and set the meter (M6) to the 0.5mA scale. Place the circuit so wind is blowing on the fan or sunlight is shining on the solar cell (B7). Set the slide switch (S5) to position B if you have wind or to position C if you have sunlight. Connect the jumper wires to the circuit and place the other ends in a cup of water, make sure the metal parts aren't touching each other.

Your power source (wind or sun) is making an electric current flow through the water, and the meter measures the current. As the current flows through the water, the water is warmed.

These small wind and solar power sources may not produce enough heat for you to notice the water getting warmer, but you could use more powerful ones to heat up a lot of water. You could then pump the water around your house in pipes to use the wind or solar heated water to warm up your house.

How do you harness the wind to heat your house? It is easy when you use electricity to help.

Another way to harness sunlight to heat homes is by using sunlight to heat water, then pumping the water around the house.

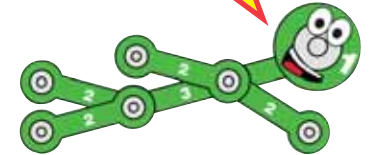

# Project #92

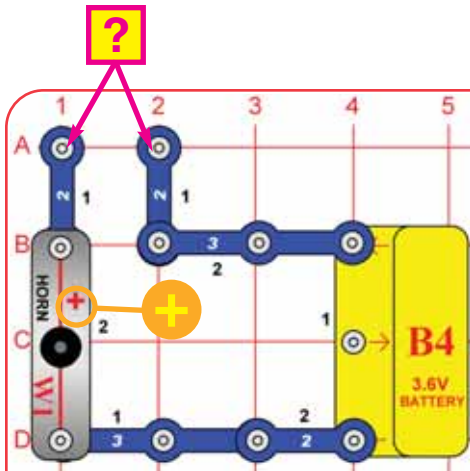

See projects 1 & 3 if you need to recharge the battery (B4).

Build the circuit shown, and touch various materials between the snaps marked with ?.

The horn (W1) will signal for materials that are good at transporting electricity. Try string, the electrodes, a shirt, plastic, paper, wood, or anything in your home.

Many electronic test instruments test wires and connections using probes and a sound device like you did here. A sound device is used so the user can focus his attention on where he puts the probes without looking at a display.

You can replace the horn with the meter (0.5mA setting) or one of the LEDs (D1 & D5) to make a visual continuity checker.

# Electrical Material Checker

Some materials, such as metals, have very low resistance to electricity and will turn on the horn. These materials are called **conductors**.

Other materials, such as paper, air, and plastic, have very high resistance to electricity. These will not turn on the horn. These materials are called **insulators**.

Copper is one of the best conductors ever found so it is used for most electrical wires. Plastic is a very good insulator so it is used around copper wires to prevent electricity from getting in or out of the wire.

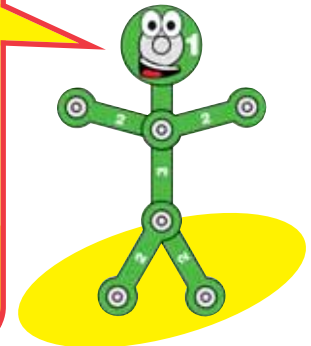



# Project #93

# Morse Code

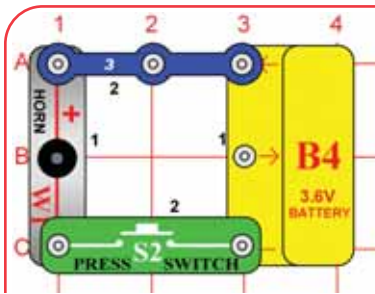

See projects 1 & 3 if you need to recharge the battery (B4).

Build the circuit and push the switch (S2) several times to send secret messages to your friends using Morse Code.

If the horn (W1) was located 10 miles away and connected to the switch and battery (B4) using really long wires, then you could still use it to send messages.

**Morse Code:** The forerunner of today's telephone system was the telegraph, which was widely used in the latter half of the 19th century. It only had two states - on or off (that is, transmitting or not transmitting), and could not send the range of frequencies contained in human voices or music. A code was developed to send information over long distances using this system and a sequence of dots and dashes (short or long transmit bursts). It was named Morse Code after its inventor. It was also used extensively in the early days of radio communications, though it isn't in wide use today. It is sometimes referred to in Hollywood movies, especially Westerns.

## MORSE CODE

|   |           |   |           |          |              |
|---|-----------|---|-----------|----------|--------------|
| A | .. _      | N | _ .       | Period   | .. _ _ _     |
| B | ....      | O | ... _ _   | Comma    | .. _ . .     |
| C | _ _ . .   | P | .. _ . .  | Question | .. _ . . . . |
| D | _ . . .   | Q | .. _ . _  | 1        | .. _ _ _ _   |
| E | .. . . .  | R | .. . . .  | 2        | .. _ _ _ .   |
| F | .. . . .  | S | .. . . .  | 3        | .. _ . . .   |
| G | _ _ . . . | T | _ . . . . | 4        | .. _ . . . . |
| H | .. . . .  | U | .. _ . .  | 5        | .. . . . .   |
| I | .. . . .  | V | .. . . .  | 6        | .. _ . . . . |
| J | _ . _ _ . | W | .. _ . .  | 7        | .. _ . . . . |
| K | _ . . . . | X | _ . . . . | 8        | .. _ . . . . |
| L | .. . . .  | Y | _ . . . . | 9        | .. _ . . . . |
| M | _ _ . . . | Z | _ . . . . | 0        | .. _ . . . . |

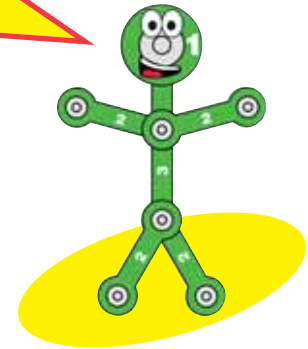

# Project #94

# Morse Light

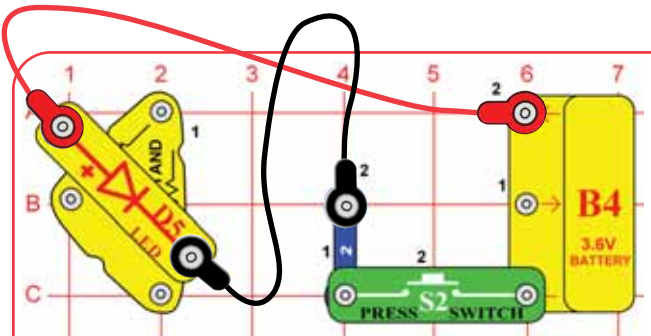

Build the circuit as shown, with the yellow LED (D5) on the pivot. Point the yellow LED towards your friends and push the switch (S2) several times to send messages to your friends using Morse Code.

You could use this system to send messages during a noisy concert, or out in the wilderness where your cell phone won't work.

During World War II Navy ships sometimes communicated by flashing Morse Code messages between ships using searchlights (because radio transmissions might reveal their presence to the enemy). Years ago, Native Americans would send messages to other tribes using smoke signals and a special code.

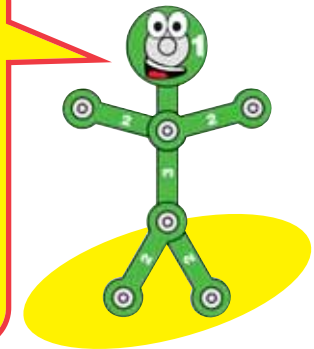



# Project #95

# Everything Circuit

See projects 1 & 3 if you need to recharge the battery (B4).

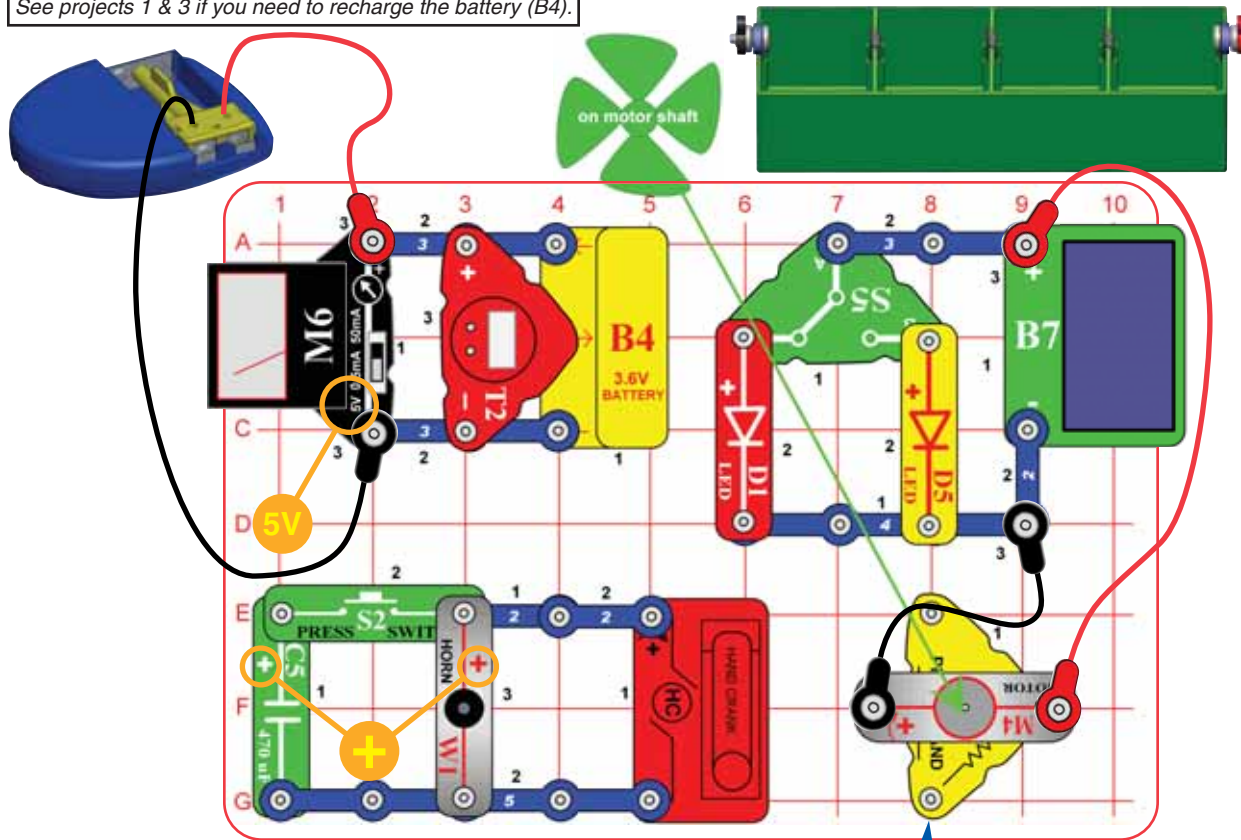

This project combines several circuits to demonstrate what you can do with Snap Circuits® Green.

Assemble the circuits shown. Install the battery eliminator into the battery compartment of the FM radio and connect it to the circuit. Plug in the earphones, turn on the radio using the volume knob and press the scan button to find a radio station. Set the meter (M6) to the 5V setting. See page 4 if you would like to set the time on the clock (T2).

The battery (B4) runs the radio and clock, while the meter (M6) monitors the battery voltage. Turn the hand crank clockwise to run the horn; pushing the press switch makes the horn louder. Place the solar cell (B7) in sunlight or near an incandescent light bulb to light one of the LEDs (D1 & D5), depending on the slide switch (S5) position.

**Note:** You should not connect the jumper wires to the LED circuit if you want to run them using the solar cell.

The LEDs may also be powered by wind or liquids. Assemble the pivot and place the motor with wind fan on it. Connect it to the circuit near the solar cell using the red & black jumper wires. Blow on the wind fan or place it in a strong wind to use it to light the LEDs.

To run the LEDs using liquid, assemble the liquid energy source using the instructions on page 4. Move the red and black jumper wires from the windmill motor to the electrodes (red wire to the copper electrode, black wire to zinc electrode). Fill the compartments with cola or juice. The solar cell is still connected to the circuit, so you may cover it to prevent it from helping the liquid run the LED.

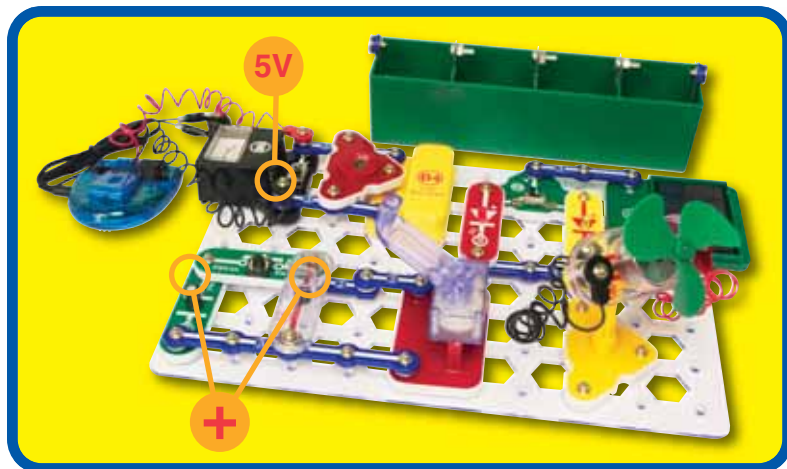

There are many ways to generate electricity, and many more ways to use it!

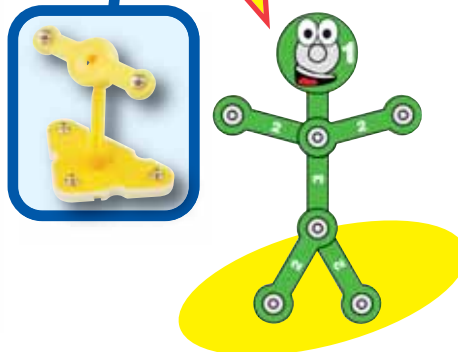



# Project #96

See projects 1 & 3 if you need to recharge the battery (B4).

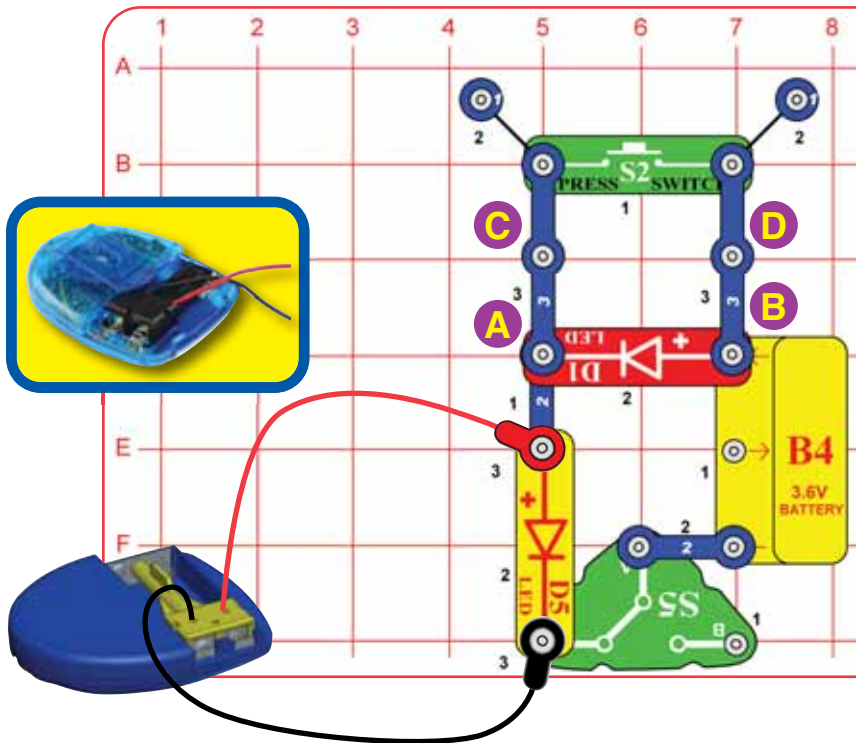

# Light Signal for Radio

Install the battery eliminator connector into the battery compartment in the radio and plug in the earphones. Set up the circuit as shown. Set the slide switch (S2) to position C, turn on the volume knob on the radio, and press the scan button to see if you can find a radio station (radio features may vary). The red LED (D1) lights, indicating that electricity is flowing to the radio, but there may not be enough to operate it.

Disconnect the black wire from the battery eliminator and the red LED gets dim or turns off. The two LED's are in series and there may not be enough voltage to light both.

Reconnect the black wire and push the press switch (S2), to bypass the red LED. All the voltage is now across the yellow LED and the radio, so the red LED is off and the yellow LED lights as the radio plays.

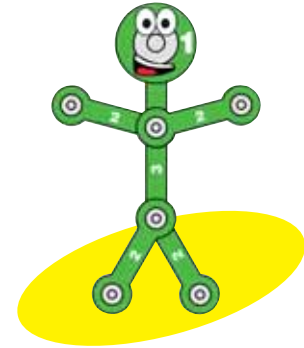

# Project #97

Modify the preceding circuit by placing the horn (W1) across the points marked, A and B ("+" side to B) and the 470 $\mu$ F capacitor (C5) across points C and D ("+" side to D).

Set the slide switch to position C and turn the radio on. The horn will sound but the red LED will not light. Press S2 and the horn stops, the yellow LED turns on, and the radio plays.

# Light & Sound Signal for Radio

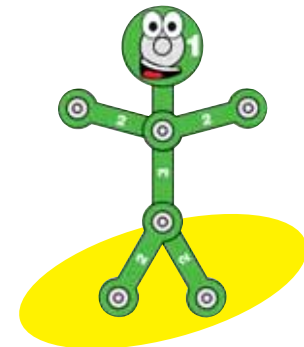



# Project #98

See projects 1 & 3 if you need to recharge the battery (B4).

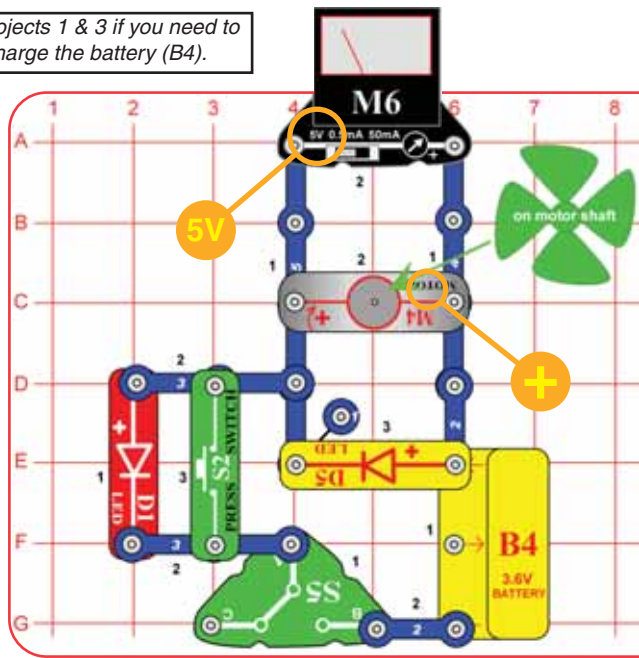

# Speed Indicator

Set the slide switch (S5) to position B; the fan spins and the red LED (D1) lights. The voltage across the motor (M4) is shown on the meter, it should be about 1V. The yellow LED (D5) is in parallel with the motor and does not light with only 1V across it. Spin the motor faster by blowing on the fan; the voltage across increases and the yellow LED lights.

Blow on the fan see what voltage it takes to turn off the red LED and turn on the yellow LED.

Pushing the press switch (S2) bypasses the red LED, so the fan spins faster and the yellow LED lights. See what the voltage is across the motor now.

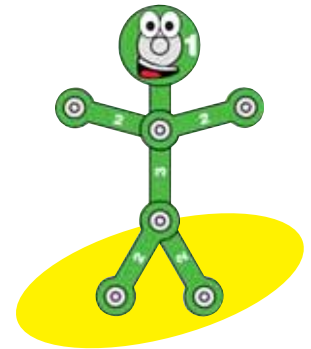

# Project #99

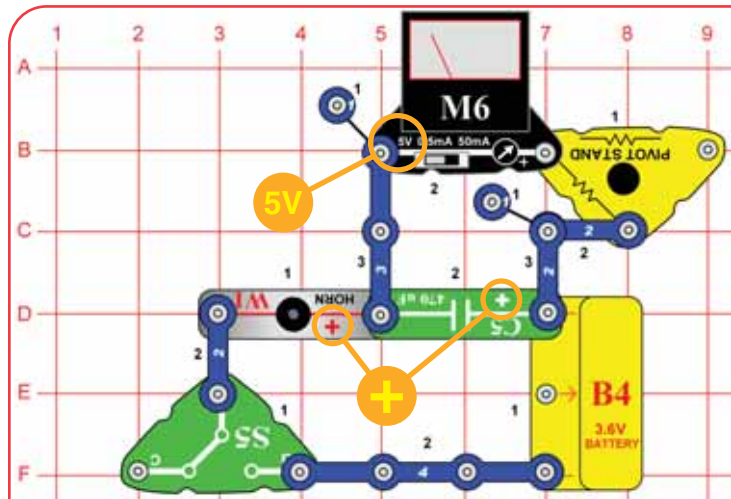

# Sound Pulse

Set the switch (S5) to position B, you hear a short tone from the horn (W1). As the 470µF capacitor (C5) charges, current flows through the horn. Set the switch to position C, and watch the voltage on the meter (M6) as the capacitor discharges. Move the switch between B and C several times slowly.

Add the press switch (S2) across base grid locations C5-C7, on level 4. When the slide switch is in position B, pressing S2 bypasses the capacitor and the horn sounds. When the slide switch is in C, pressing S2 discharges the capacitor instantly.

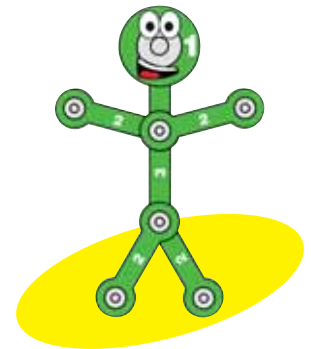



# Project #100

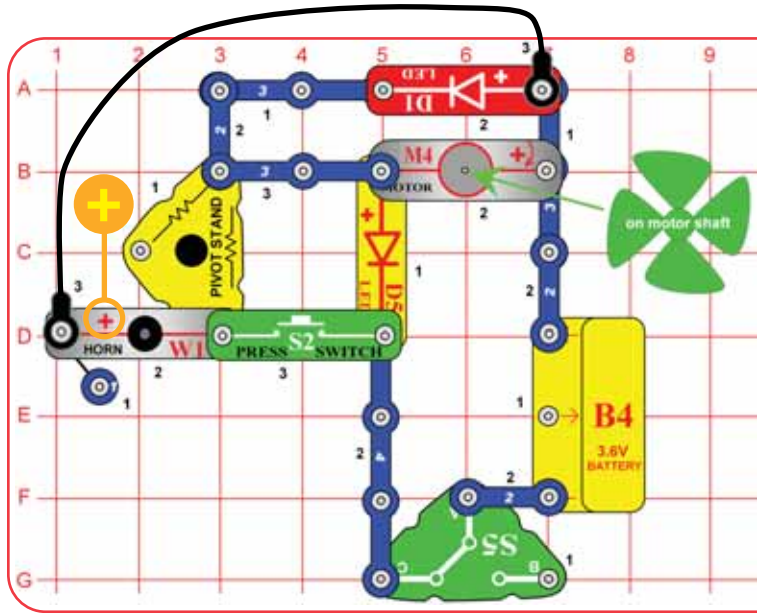

See projects 1 & 3 if you need to recharge the battery (B4).

In this circuit we use the LED's (D1 & D5) and horn (W1) too indicate if the motor (M4) is spinning. Set the slide switch (S5) to position C, the yellow LED lights, indicating the motor is not spinning. Pushing the press switch (S2) bypasses the yellow LED, and it turns off. The voltage across the motor, red LED, and horn increases so they activate.

Check your thermostats at home and see if an LED or fan symbol lights when the heater or air-conditioner is on.

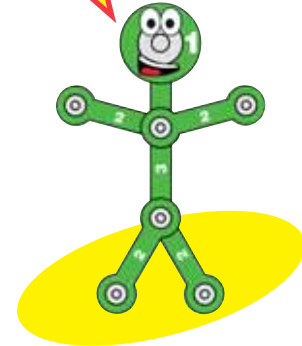

# Project #101

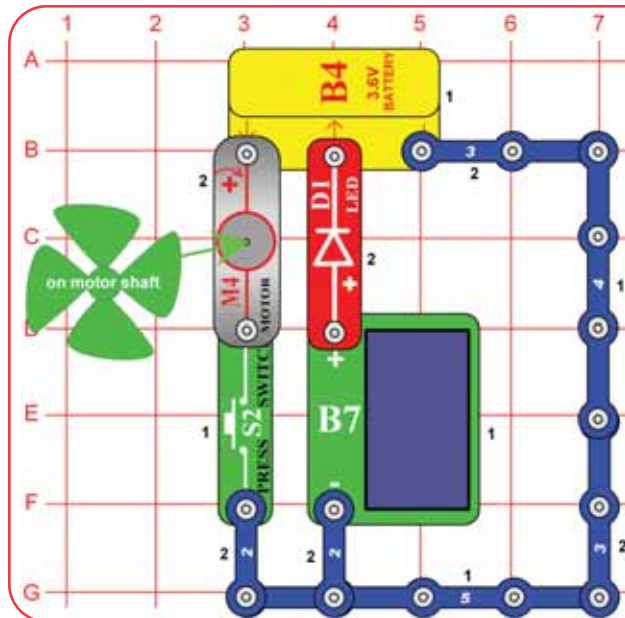

In this project you'll convert one form of energy to another. Place the solar cell in sunlight or about 12 inches from an incandescent light bulb of 60W or more. Adjust the light on the solar cell to make the red LED (D1) brightest. The solar cell converts light energy into electrical that lights the LED and charges the battery (B4).

The electrical energy charges the battery, converting it into a chemical form. When you press switch S2, chemical energy in the battery makes electrical energy, which runs the motor. The spinning motor shaft is another form of energy called motion.

If you prefer, you can mount the solar cell on the pivot stand, connect it to the circuit using the red & black jumper wires, and then adjust the pivot so the solar cell faces the light.

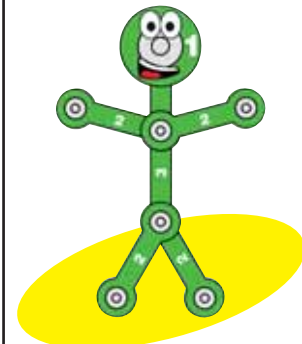





# Project #102

See projects 1 & 3 if you need to recharge the battery (B4).

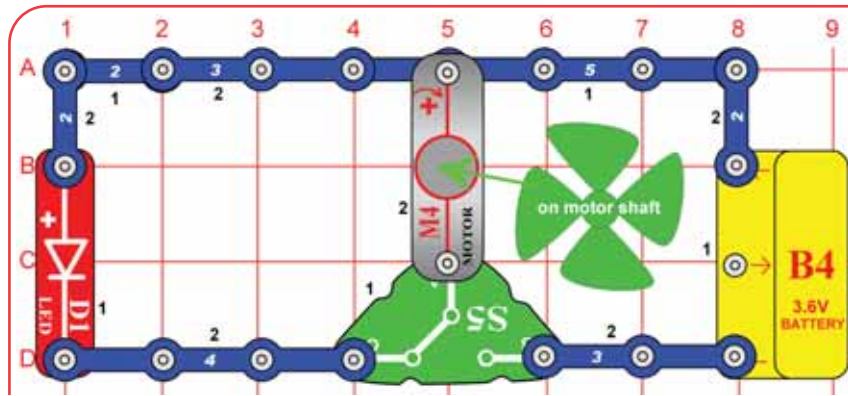

# Energy Conversion

Set the slide switch (S5) to position B. Some of the chemical energy in the battery becomes electricity, which is converted into mechanical energy of motion by the motor (M4).

Now set the slide switch to position C. Some the mechanical energy in the motor generates electricity, which travels to the red LED, where it becomes light.

Part B: Replace the motor with the yellow LED (D5) or the horn (W1). Set the slide switch to position B. Now the chemical energy in the battery becomes light energy or sound energy (air pressure variations).

Part C: Replace the battery with the hand crank. Now you can convert mechanical energy of motion to chemical energy in the battery, then to motion, light, or sound.



# Project #103

# Small Energy Conversion

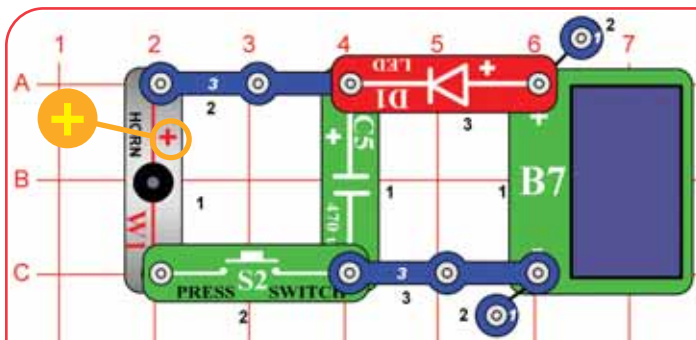

The capacitor stores energy as an electric field, similar to the magnetic field of a magnet. It can only store a small amount of energy in this way.

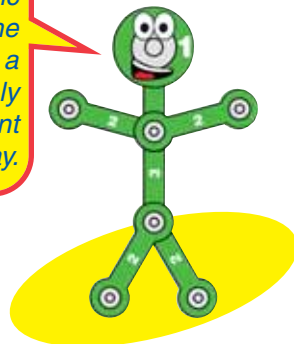

Build the circuit shown, and place the solar cell (B7) in sunlight or close to an incandescent lamp for a few seconds. The red LED (D1) should light briefly. The solar cell converted some light energy into electrical energy, which was stored in the 470µF capacitor (C5).

Press the switch (S2). The horn (W1) makes a brief sound. The electrical energy in the capacitor was converted to sound waves (variations in air pressure) by the horn.

Part B: Replace the horn with the yellow LED (D5). Now the yellow LED converts the energy stored in the capacitor back to light.

Part C: Replace the yellow LED with the motor and wind fan. Now the energy stored in the capacitor is converted to mechanical motion by the motor. The fan will not move very much.



# Project #104 Mechanical Energy Conversion

Replace the solar cell with the hand crank. Now you can convert mechanical energy to electrical energy in the capacitor, then to sound, light, or motion.



# Project #105

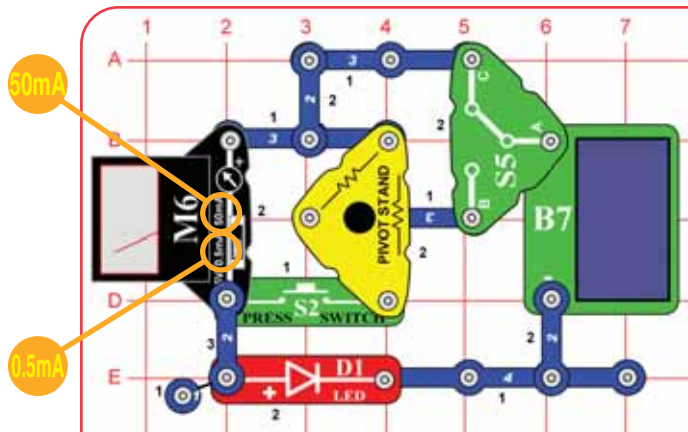

# Triple Current Meter

Build the circuit shown. This circuit measures current using several scales on the meter (M6). Set the slide switch (S5) to position C. Place the solar cell (B7) in sunlight or near an incandescent lamp, and vary the light on it. Use the 0.5mA or 50mA settings on the meter to measure the current through the red LED (D1).

If the current is too high to measure on the 0.5mA setting and too low to measure on the 50mA setting, use 0.5mA and push the press switch (S2); this uses a resistor in the pivot stand to change the scale to 5mA.

Set the slide switch to position B. This places a high resistor (in the pivot stand) in series with the LED. Measure the current now.

If you don't have a suitable light source, you can use the battery (B4) in place of the solar cell.

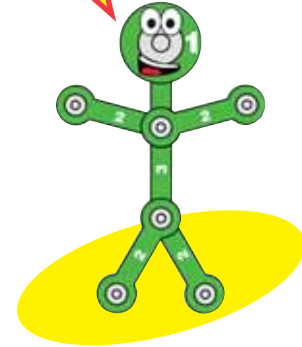

# Project #106

See projects 1 & 3 if you need to recharge the battery (B4).

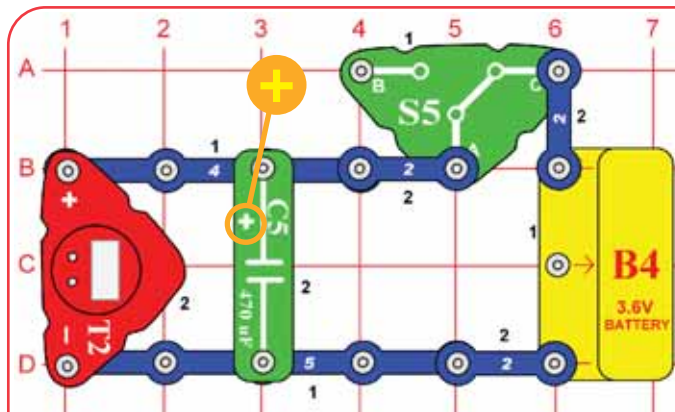

# Clock with Memory

Build the circuit, and set the switch (S5) to position B to turn on the clock. If you turn off the switch or disconnect the power source (the B4 battery), the clock will still work for a while. The 470µF capacitor (C5) stores enough electricity to run the clock for a while during power disruptions. If you remove the capacitor, the clock will turn off when you turn off the switch.

See page 4 if you would like to set the time.

Many clocks use capacitors or small batteries as backups in case the power goes out for short periods.

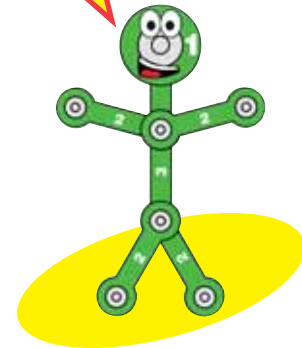



# Project #107

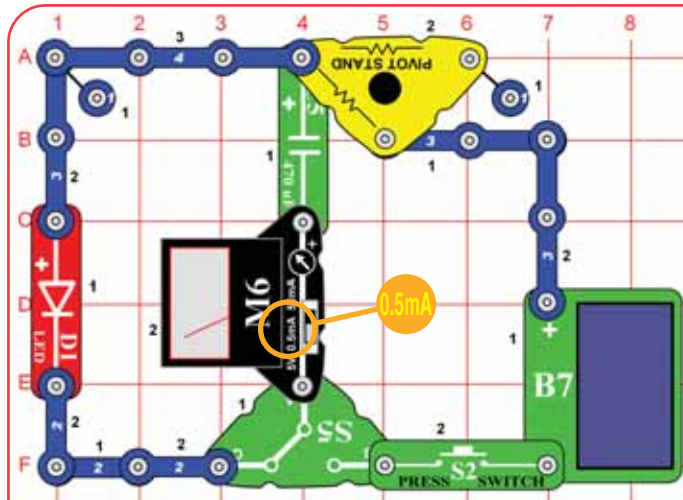

# Capacitor Charging

Build the circuit shown. Set the meter to the 0.5mA setting. Set the slide switch (S5) to position B, place the solar cell (B7) in sunlight or near an incandescent lamp, and push the press switch (S2). The solar cell slowly charges up the 470 $\mu$ F capacitor (C5), and the meter shows the current.

Set the slide switch to position C to discharge the capacitor, making the red LED (D1) flash.

Set S5 back to B, push S2 to see the current, and then set S5 back to C to see the flash.

If you don't have a suitable light source, you can use the battery (B4) in place of the solar cell.

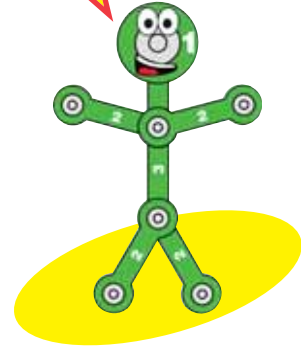

# Project #108

See projects 1 & 3 if you need to recharge the battery (B4).

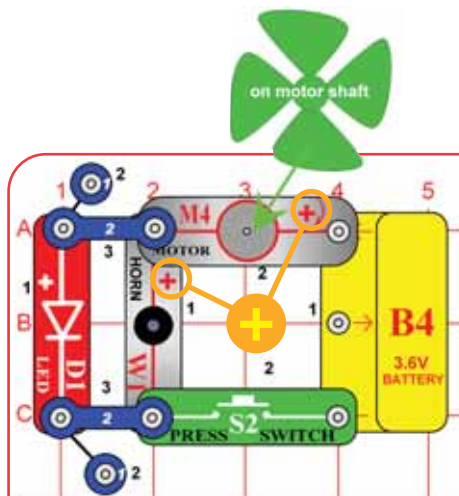

# Stopped Motor Alarm

Build the circuit shown and press the switch (S2) to spin the fan on the motor (M4). The horn (W1) sounds briefly until the fan gets going.

Stop the fan with your finger. The horn sounds an alarm to let you know that the fan is not spinning.

Warning systems like this are often used to alert us when something is wrong with a mechanical system.

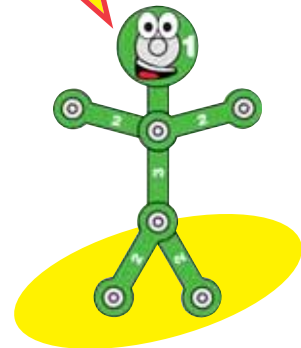



# Project #109

See projects 1 & 3 if you need to recharge the battery (B4).

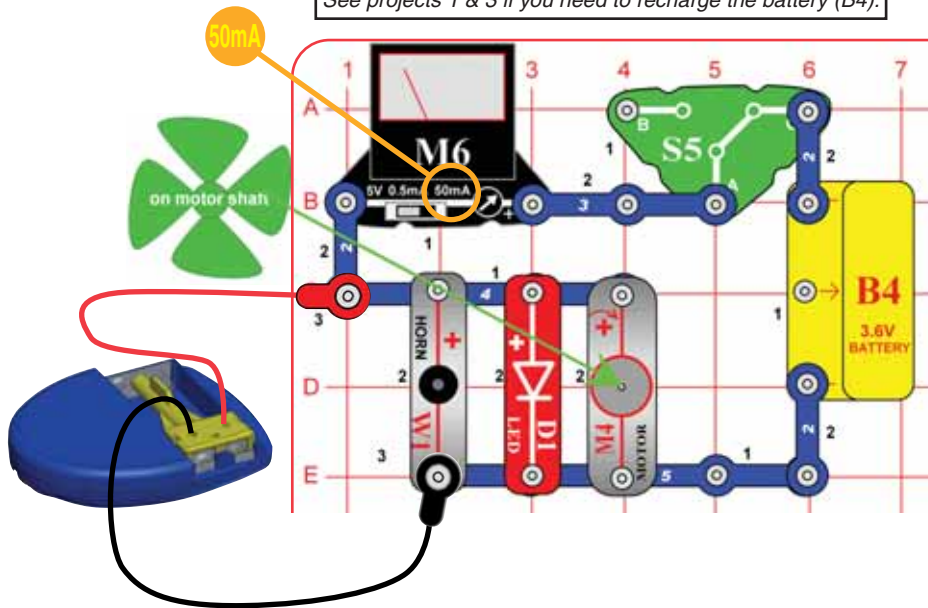

# Saving Energy

Build the circuit shown. Set the meter to the 50mA setting. Set the slide switch (S5) to position C. The battery operates the radio, horn, red LED, and motor, just like batteries operate stuff in your home. The meter shows how much current is used to operate them; the more current is used, the faster the battery will run out.

You can make the battery last longer if you turn off some things. Remove the radio, horn, LED, or motor from the circuit, and see how much the current drops. Then remove another. Some devices use more current than others, so it helps most if you disconnect the highest current device - find out which one it is.

Reducing how much energy we use is just as important as finding new sources of clean energy.

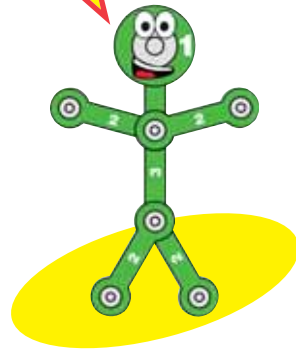

# Project #110

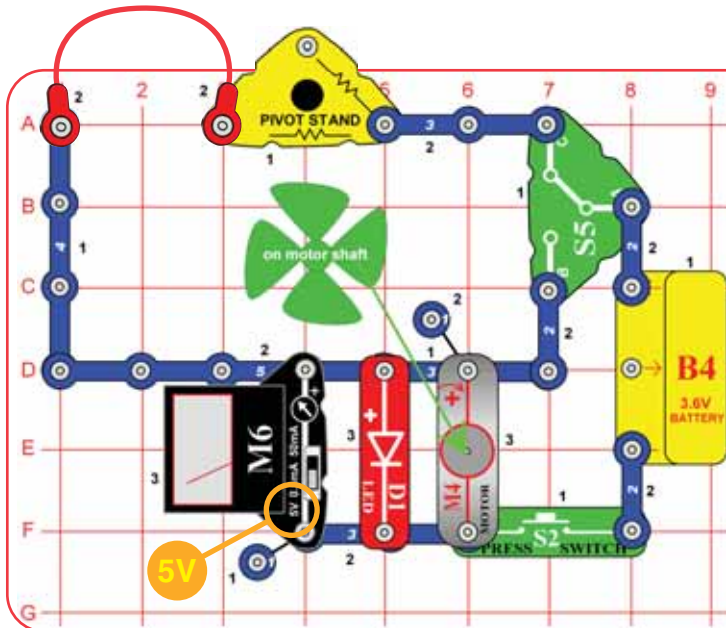

# Energy Transmission Loss

Push the press switch (S2); the motor (M4) spins the fan, the red LED (D1) lights, and the meter (M6) measures the voltage across them.

If the slide switch (S5) is in position B, the electric current takes the short path to the meter/LED/motor. If the slide switch is in position C, the current takes the longer path, and the voltage available at the meter/LED/motor is lower due to more resistance in the path.

Remove the LED or motor and see how the voltage changes. If less current is used, less voltage will be lost along the way.

Electrical wires have low resistance, but when you are transporting large amounts of electricity over large distances (such as between power plants and cities), even low resistance causes large power losses. In this circuit a resistor in the pivot stand simulates having a very long wire.

When electric power companies transport electricity long distances (like between power generating plants and cities), they use high voltages and low currents since this reduces power loss in the wires. Transformers convert this to 120V, which is supplied to homes and offices.

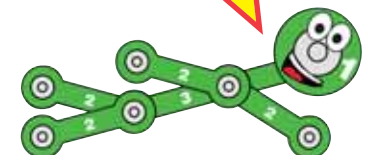



# Project #111

See projects 1 & 3 if you need to recharge the battery (B4).

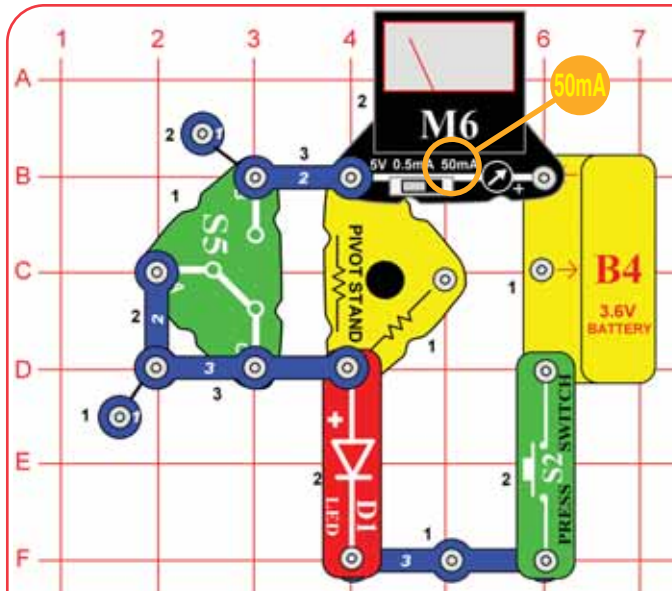

# Regulating Power

Build the circuit and push the press switch (S2). Use the slide switch (S5) to adjust the red LED (D1) brightness. Replace the red LED with the yellow LED (D5) or the motor (M4) and use the slide switch to adjust it for brightness or speed.

The meter shows that the current is lower when the LED/motor is set for lower brightness/speed.

Here the slide switch adds resistance to reduce the current used, saving energy.

In your home you should always run lights and motors at the lowest brightness or speed needed for what you are doing. This reduces the need for electricity, which saves you money and reduces pollution.

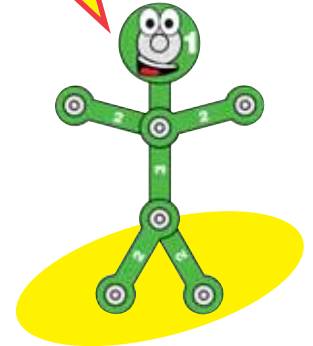

# Project #112

# Sun & Wind Light

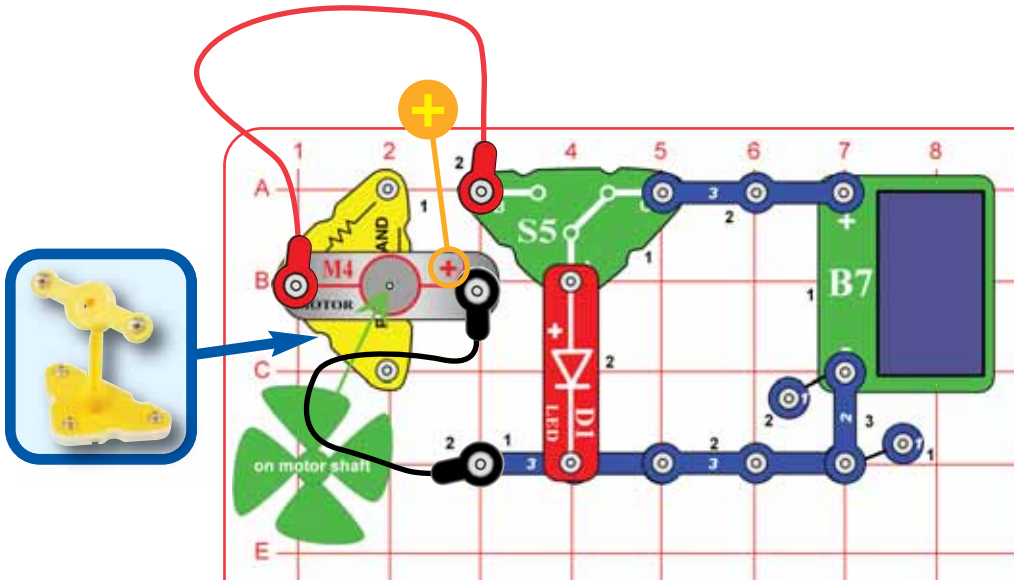

Build the circuit shown, with the motor mounted on the pivot stand like a windmill. Use either sunlight or wind power to run the red LED (D1). Select the one that is available using the slide switch (S5).

During the day, the sun powers the LED using the solar cell. At night, the wind powers the LED. This circuit does not consume any fuel, and causes no pollution.

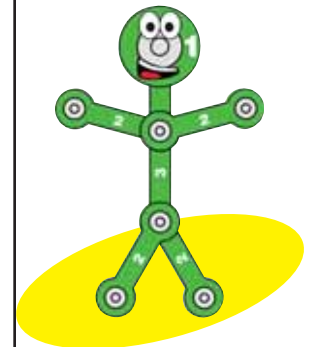



# Project #113

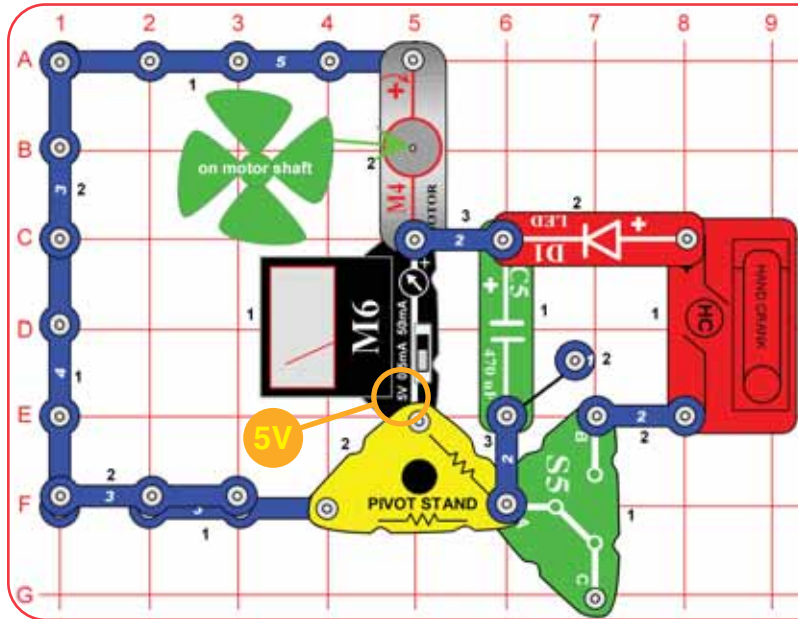

# Hybrid

The motor is powered by the hand crank or stored energy from the 470µF capacitor (C5). It might be called a hybrid, because it runs on power from either source. However, the capacitor does not store much energy, so it will run the motor for only a very short time. If the rechargeable battery were used here, the motor would run for much longer.

Set the slide switch (S5) to position B and turn the hand crank (HC). The red LED (D1) lights, the meter measures the voltage, and the fan spins.

The meter scale is 10V (not 5V), due to a scaling resistor in the pivot stand.

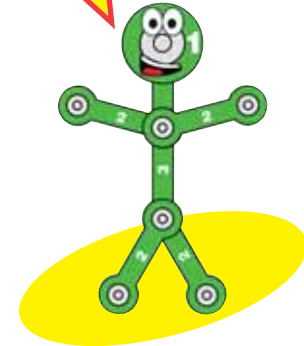

# Project #114

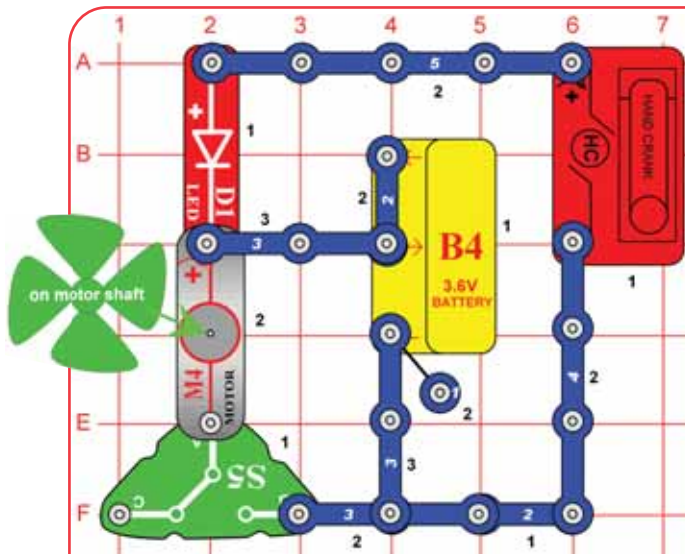

# Hybrid Car Concept

This circuit demonstrates the concept of hybrid cars. A power source (the hand crank is used here) charges a battery (B4 here) in a car. The car has an electric motor (not a gasoline powered motor), which is powered by electricity from the battery. Some electric cars also have gasoline powered motors as backups, in case you are driving a long distance and your battery runs out of charge.

Set the slide switch (S5) to position C and turn the hand crank (HC). The red LED (D1) lights when the crank is charging the battery (B4).

Set the slide switch to position B to run the motor (M4) using the battery. If you turn the crank now, it will both charge the battery and run the motor.

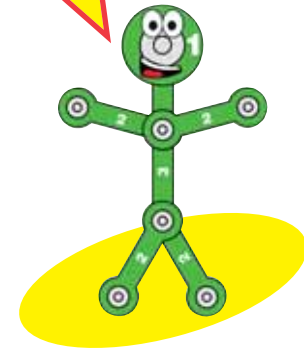



# Project #115

See projects 1 & 3 if you need to recharge the battery (B4).

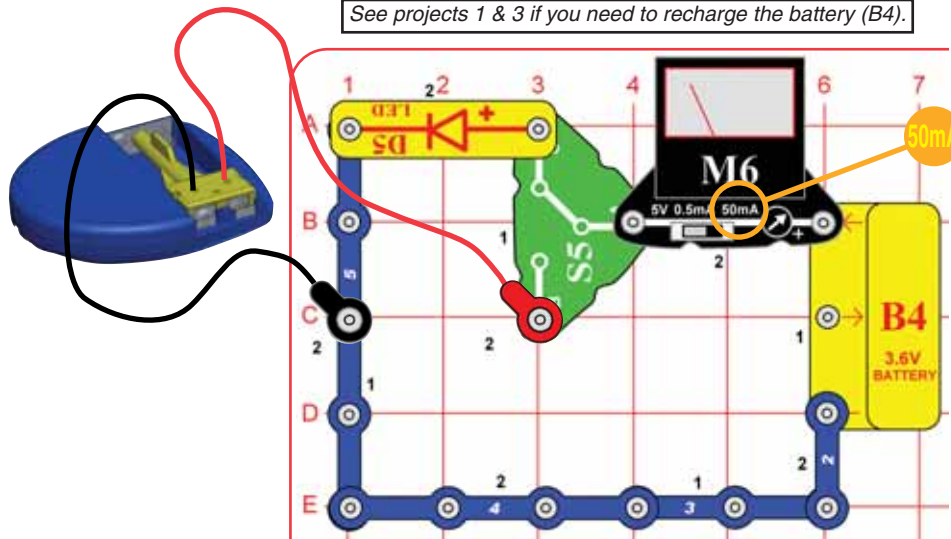

# LED or Bulb?

Compared the light produced and current used by the LED and light bulb. LEDs need a lot less energy to produce the same amount of light as ordinary light bulbs, and are being increasingly used to light homes. LEDs also last longer.

Install the battery eliminator in the radio and build the circuit shown. Turn off the volume knob on the radio. Set the slide switch (S5) to position C, the meter (M6) shows the current for the yellow LED (D5).

On most models, your radio has a light bulb. Set the switch to position B, and push the LIGHT button on the radio. The meter shows the current, it should be high.

Your radio may draw current even when the radio and light bulb are off. This is due to circuitry in the battery eliminator, which protects the radio from voltages over 3V.

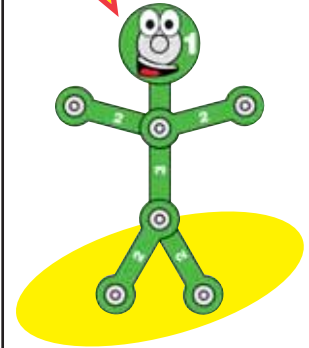

# Project #116

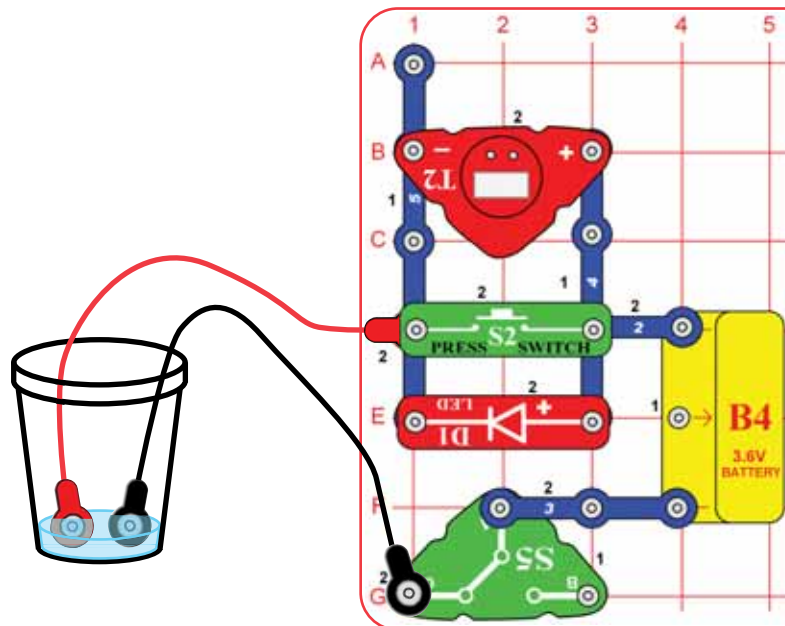

# Water Timer

Set the slide switch (S5) to position C. Place the loose ends of the red & black jumper wires into a cup of water without the metal parts touching. The red LED (D1) should light dimly and the clock (T2) should run, but it depends on your local water supply. Add salt to the water if they are off or to make them brighter.

Remove the water, and push the press switch (S2) to reset the clock. Place the empty cup under a faucet or a gutter drain. When water goes into the cup, the clock will start. If you go away and return, you can use this timer to see how long ago water entered the cup.



# Project #117

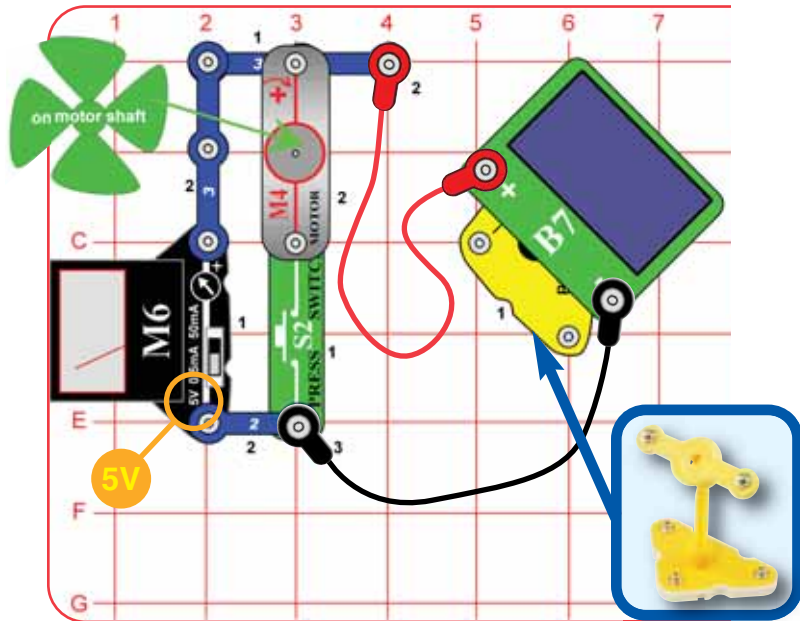

# Solar Fan

*The solar cell cannot produce as much current as the fan needs, so the voltage drops.*

*The same thing happens with water. A pump might push water through a narrow pipe at high pressure, but if you connect the same pump to a much larger pipe, the pressure drops because the pump can only push so much water.*

Mount the solar cell (B7) on the pivot stand as shown, and place it in sunlight or near an incandescent lamp. The meter (M6) measures the voltage produced.

Press the switch (S2) to turn on the fan (the M4 motor), you may need to give it a push to get it started. The meter shows the voltage is much lower now with the solar cell running the fan.

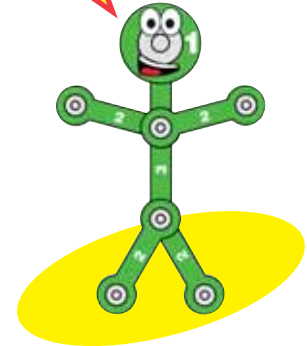

# Project #118

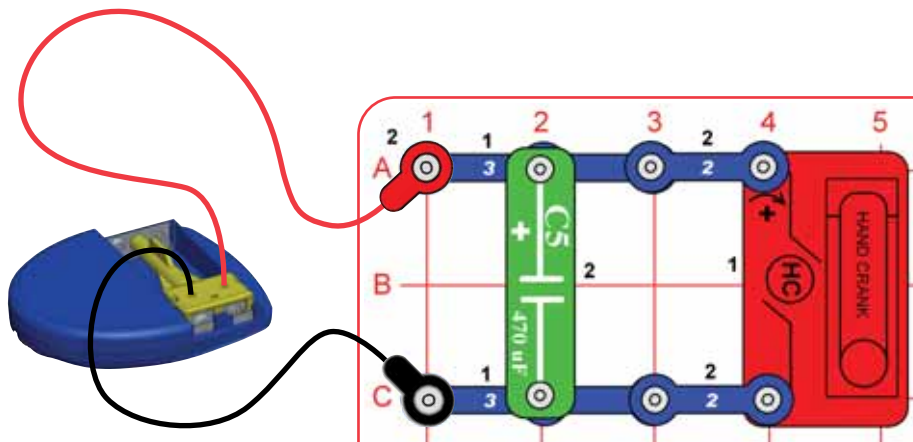

# Hand Radio

Install the battery eliminator connector into the battery compartment in the FM radio. Connect the red and black snap wires to the circuit as shown. Plug the earphones into the radio and place them earphones in your ears. Turn the volume knob clockwise to turn on the radio.

Turn the hand crank (HC) to run the radio. Press the scan button several times to see if you can receive any radio stations.

The electricity produced by your hand crank is free and does not make any pollution. Your radio can also be used with normal non-rechargeable "AAA" type batteries, but these would need to be replaced regularly.

*You can take this radio anywhere without worrying about batteries, but you may not get good reception everywhere.*

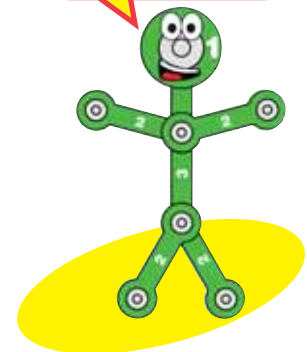





# Project #119

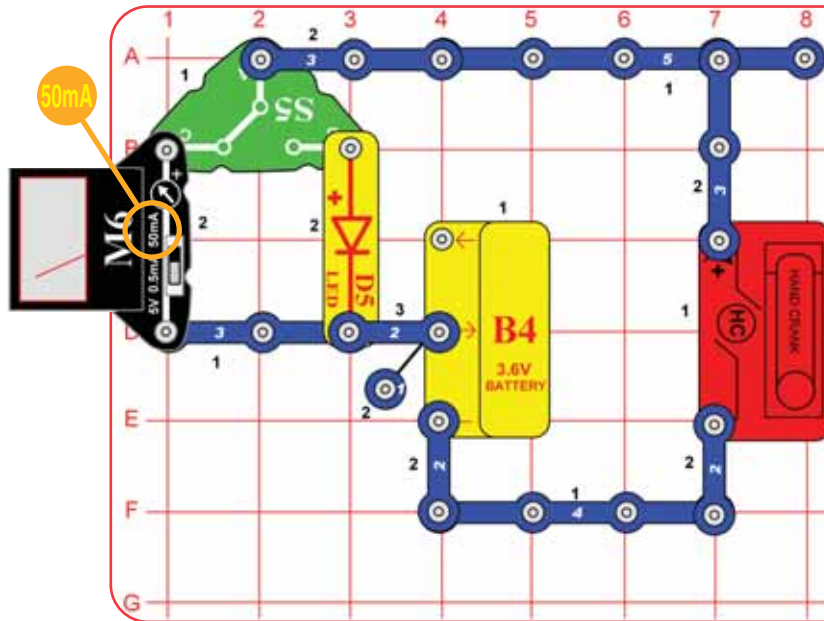

# Hand Charger

Use the hand crank (HC) to charge the battery (B4), the meter (M6) or yellow LED (D5) show how fast you are charging it.

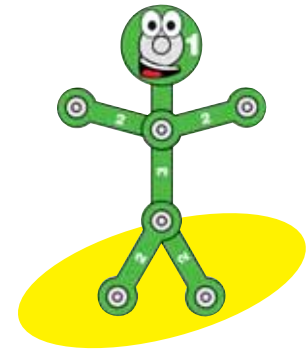

# Project #120

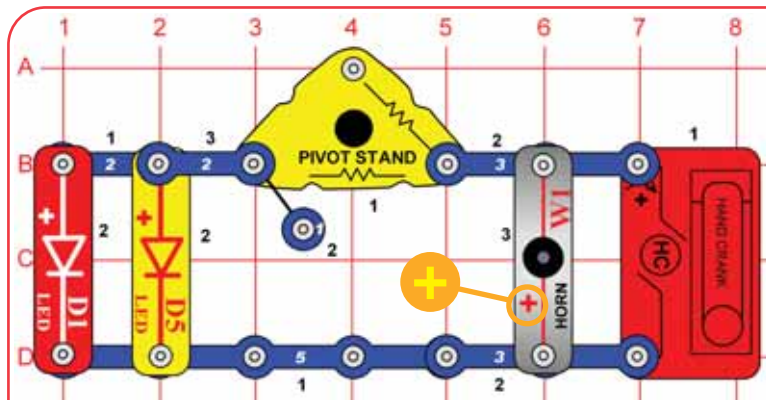

# Parallel Cranking

The yellow LED needs a little more voltage to turn on, but can get much brighter. LEDs are manufactured with two regions of permanent electrical charge. Once the voltage exceeds a turn-on level, the resistance becomes very low in one direction, and some energy is emitted as light.

Turn the hand crank (HC) slowly clockwise, just enough to turn on the red LED (D1). Then crank just a little faster, until the yellow LED (D5) also comes on. Then crank fast to see how bright each LED will get (but don't crank excessively fast).  
If you turn the crank counter-clockwise the LEDs will not light, but the horn (W1) sounds.

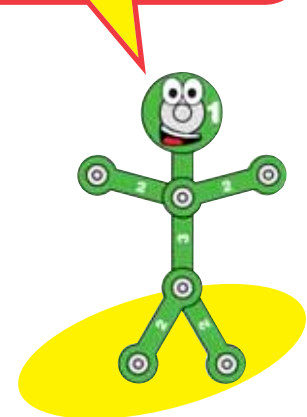



# Project #121

# Hard To Crank

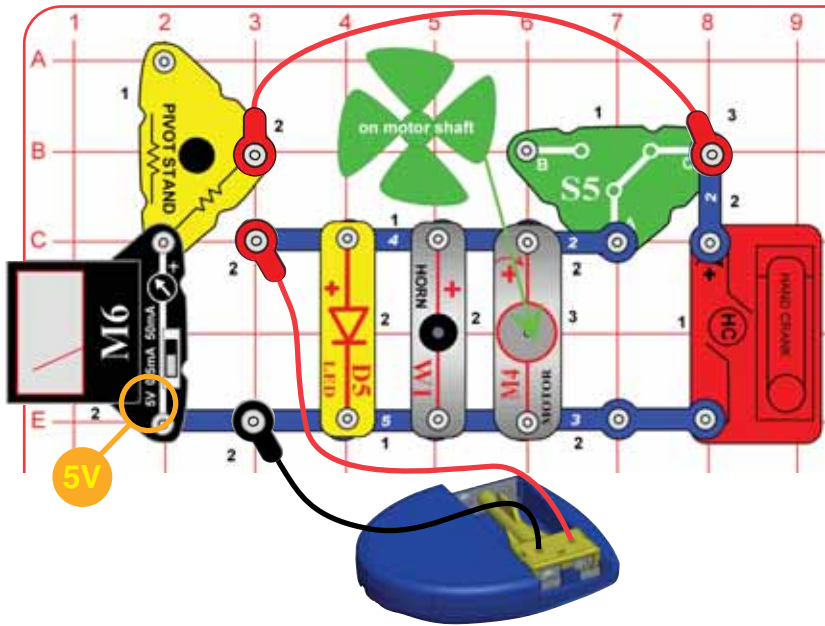

*The crank is easier to turn when devices that need lots of electric current do not load it down. It is like you trying to throw rocks - you can throw small rocks much farther than you can throw heavy ones.*

Set the slide switch to position B, and turn the hand crank (HC). Notice how easy it is to turn the crank, and how high the voltage gets. A resistor in the pivot stand changes the scale to 10V, so double the voltage shown on the meter.

Set the slide switch to position C and turn the crank clockwise. The crank runs the radio, LED, horn, and motor. Notice how much harder it is to turn the crank now, and how the voltage doesn't get as high.

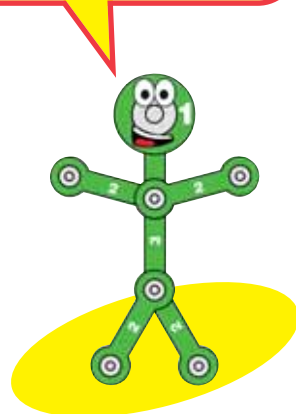

# Project #122

# Slow In Flash Out

See projects 1 & 3 if you need to recharge the battery (B4).

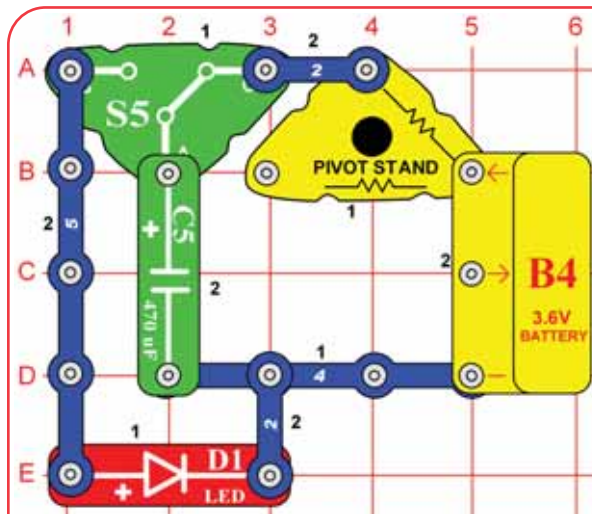

The electrons slowly trickle into the 470µF capacitor (C5) through a 10KΩ resistor (in the pivot stand) when the switch is in position C. If you wait and let the capacitor charge up it will flash nicely when you switch to the left. If you are not patient, and switch back too quickly your flash will be weak.





# Project #123

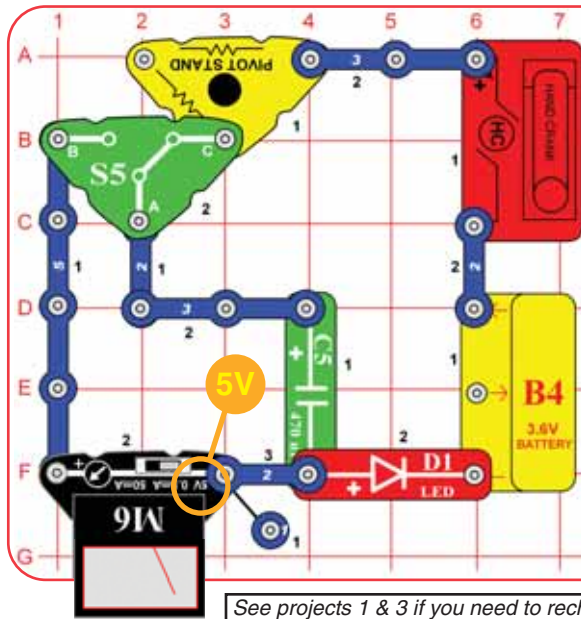

# Filling Station

The 470µF capacitor (C5) is a storage device, so it would be nice to know when it is filled to capacity. With the slide switch (S5) in position C, turn the hand crank (HC) until the red LED (D1) no longer produces light. When the capacitor is fully charged, the current is blocked and the light cannot turn on.

Flip the switch to the left to show the voltage across the capacitor, but at the same time it will use current to move the meter and the charge will drop as you read it.

Did you ever wonder how long capacitor C5 could hold its charge? Try filling it up and waiting a while before taking a reading.

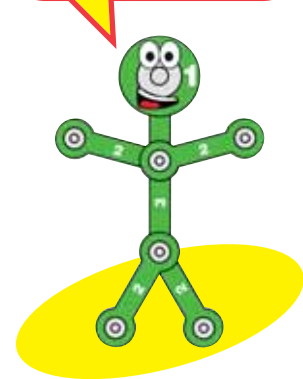

# Project #124

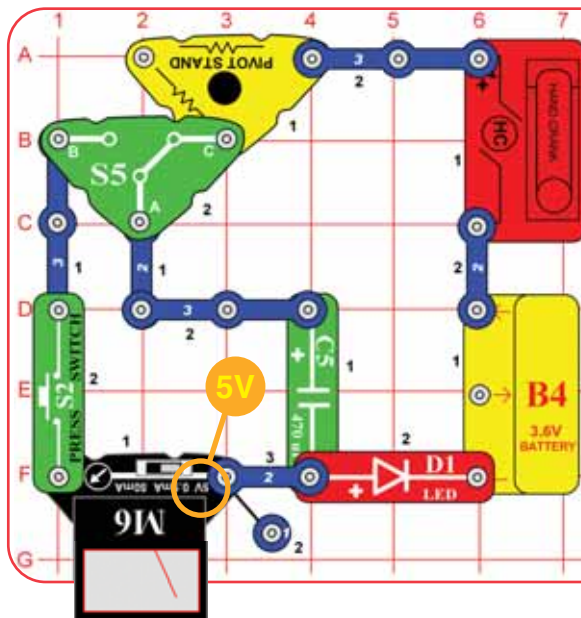

# Gas Pedal

I sure would not get very far if my electric car used a capacitor to store energy. I guess this is why they all use batteries and carry a gas driven charger to charge the batteries up when they get low.

Modify the circuit to include the press switch (S2), as shown. With the slide switch (S5) in position C, turn the hand crank until the red LED (D1) no longer produces light. When the capacitor is fully charged, the current is blocked and the light cannot turn on.

Flip the slide switch to the left and notice that the meter does not move. The press switch is open and stops current from flowing until it is pressed, just like a gas peddle stops gasoline from flowing when the car is stopped.

Press S2 on and off a few times to send current to the meter.

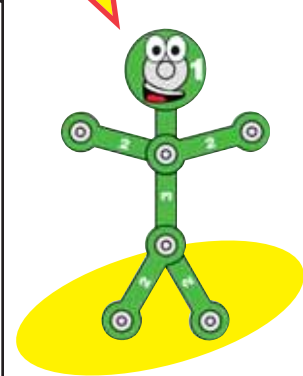



# Project #125

See projects 1 & 3 if you need to recharge the battery (B4).

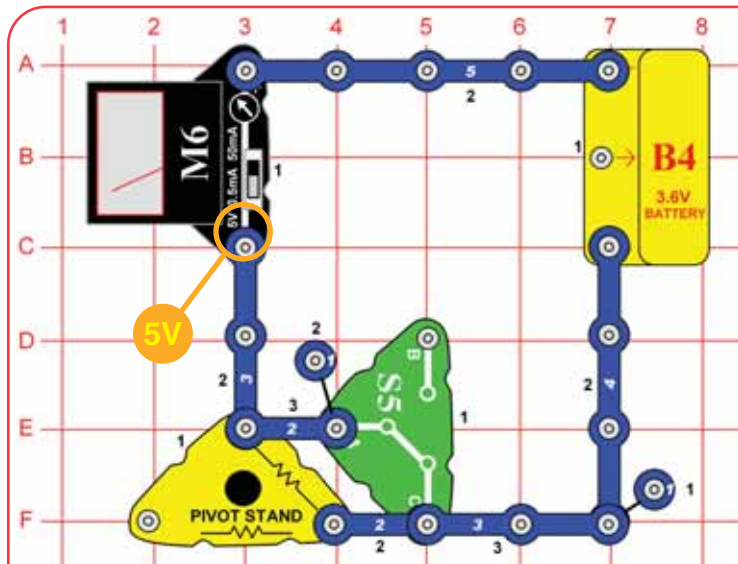

# Volt Meter

To make a voltage measurement, the meter (M6) is set to 5V and connected in parallel between the two points where the measurement is to be made. Since the voltmeter is in parallel and has a high resistance, very low current flows through it.

To measure the voltage of the battery (B4), set the slide switch (S5) to position C. Look at the scale and read the voltage, it should be over 3 volts. If the voltage is less than 3 volts, you need to charge the battery.

You can change the meter scale from 5V to 10V by adding a 10KΩ resistor in the pivot stand in series with the meter. Set the switch to position B. The meter pointer drops to a lower position since each segment now equal 2V.

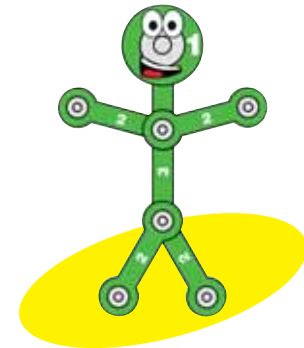

# Project #126

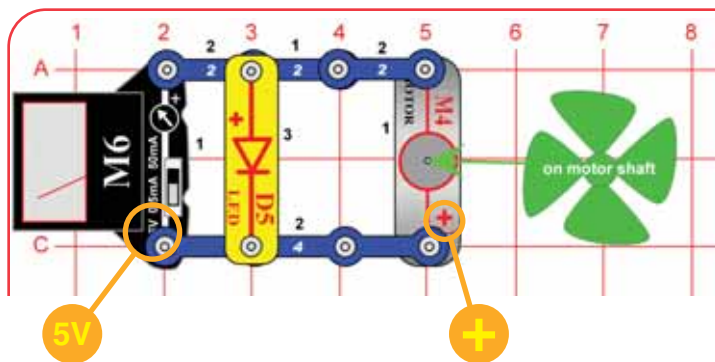

# Anemometer

Wind speed is important for wind energy. Wind turbines need a constant, average wind speed of about 14 miles per hour before the wind turbines can generate electricity.

The energy in the moving wind can be used to generate electricity. An anemometer is a device used for measuring wind speed, and is one instrument used in a weather station. The term comes from the Greek word *anemos*, meaning wind. Leon Battista Alberti invented the anemometer.

Set the meter (M6) to the 5V setting. Slowly blow on the fan and notice the reading on the meter. The meter measures the voltage generated by the spinning shaft on the motor. The faster the shaft spins, the greater voltage generated. See how fast the fan must spin to light the LED.

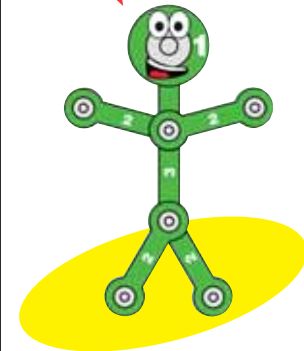



# Project #127

See projects 1 & 3 if you need to recharge the battery (B4).

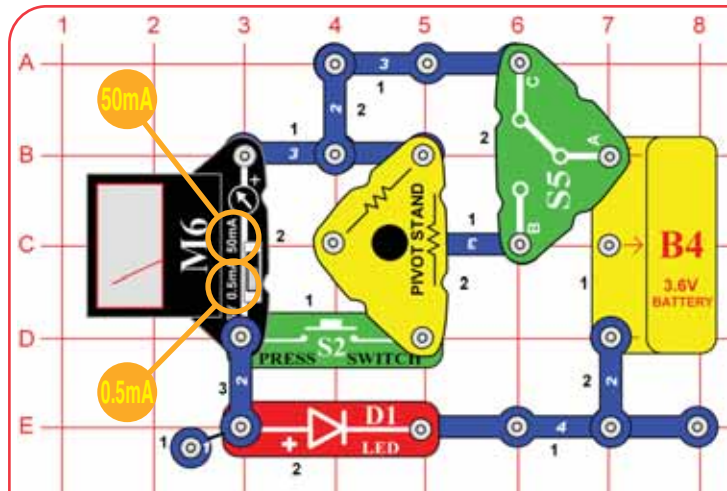

# Current Meter

To make a current measurement, you need to break the circuit, so that the meter can be connected in series. The meter should not change the circuit, so it must have a very low resistance.

### 50mA Scale:

To measure the current through the red LED (D1), set the meter to 50mA and the slide switch (S5) to position C. Look at the meter and read the current, it should range from 20-25mA (2-2.5 on scale).

### 0.5mA Scale:

Set the slide switch to position B, placing a 10KΩ resistor in the pivot stand in parallel with the meter. Set the meter to the 0.5mA scale and the meter pointer should show about 1.5, which is 0.15mA. The LED will not be as bright, due to the lower current.

### 5mA Scale:

You can change the scale to 5mA by pushing the press switch (S2). This connects a 47Ω resistor in the pivot stand in parallel with the meter, diverting enough of the current away from the meter to change the scale to 5mA.

Changing the resistance of the meter changes the scale reading.

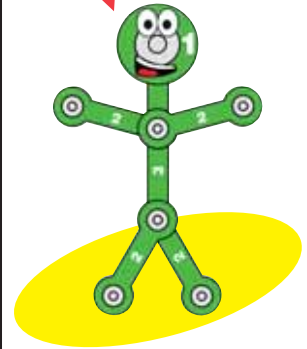

# Project #128

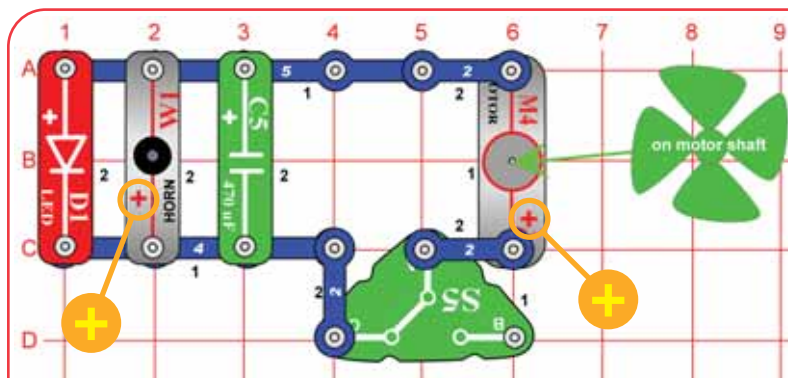

# Wind Direction

Set the slide switch (S5) to position C and spin the fan clockwise. The rotating shaft on the motor (M4) generates a current and the horn (W1) sounds. Current flows from the motor to the positive side of the horn, so the red LED (D1) does not light. Rotate the horn so the "+" is on top and spin the fan again. Did the horn sound? Position the horn back so "+" is on the bottom.

Now rotate the fan counter-clockwise, generating a current in the opposite direction. The LED lights but the horn does not sound.

As the fan spins faster, the horn sounds louder or the LED lights brighter. You can use this circuit as a wind direction or speed indicator.

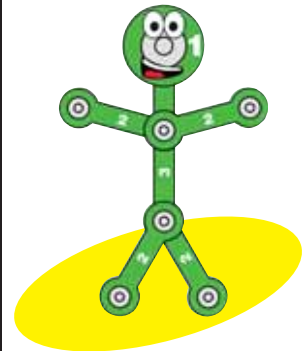



# Project #129

# Windy Radio

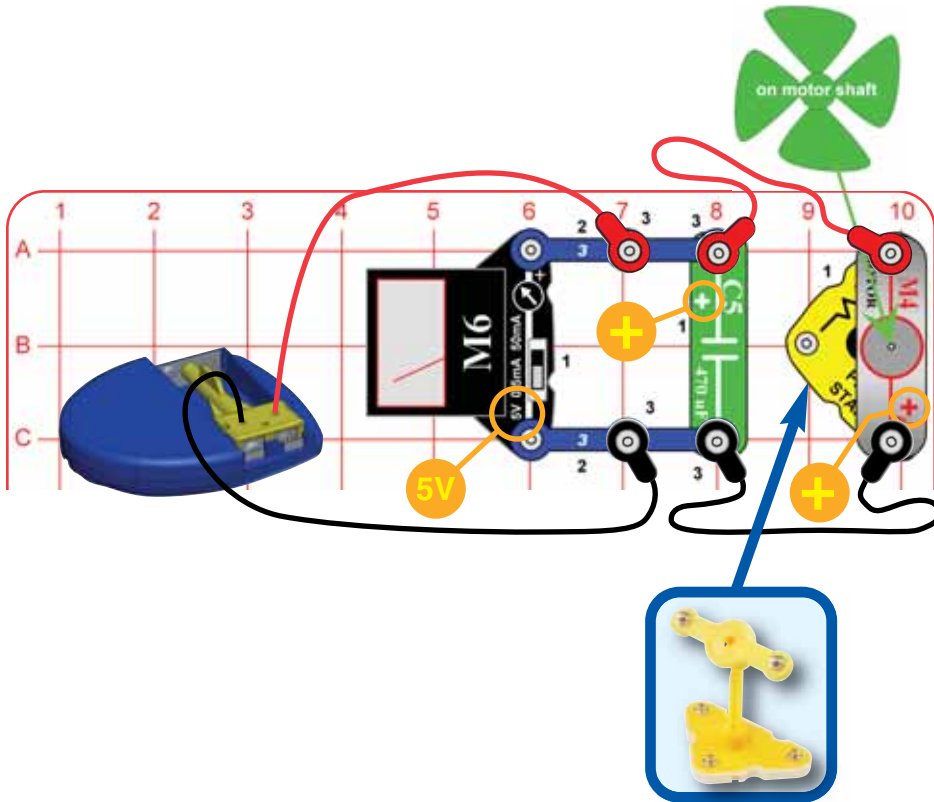

Place the wind fan on the motor (M4) and mount the motor on the pivot. Install the battery eliminator connector into the battery compartment in the FM radio. Connect the red and black snap wires to the circuit as shown. Plug the earphones into the radio and place them earphones in your ears. Turn the volume knob clockwise to turn on the radio. Set the meter (M6) to the 5V setting.

Hold the "windmill" in a strong, steady wind (such as near an electric fan). The meter measures the voltage produced by the windmill; you need at least 2V to get any sound and nearly 3V for good quality. Press the scan button several times to see if you can receive any radio stations.

The electricity produced by your "windmill" is free and does not make any pollution, but you need a strong, steady wind. Your radio can also be used with normal "AAA" type batteries, but these would need to be replaced regularly.

The radio is a sensitive electronic device and needs a steady 3V power source to work properly. The 470µF capacitor (C5) helps to steady the voltage produced by the windmill, but you need a strong wind to produce 3V with the windmill while running the radio.

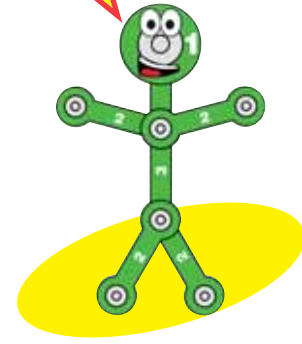

# OTHER SNAP CIRCUITS® PRODUCTS!

Contact Elenco® to find out where you can purchase these products.

## Snap Circuits® Jr. Model SC-100



**Build over 100 projects**

**Including:**

- Flying saucer
- Spin draw
- Sound activated switch
- Alarm circuit

**Contains over 30 parts**

**Including:**

- Photoresistor
- Motor
- Music IC
- Space War IC

## Snap Circuits® Extreme Model SC-750



**Build over 750 projects**

**Including:**

- Strobe light
- Transistor AM radio
- Electromagnetism
- Rechargeable battery

**Contains over 80 parts**

**Including:**

- Solar cell
- Electromagnet
- Vibration switch
- Computer interface

## Snap Circuits® Model SC-300



**Build over 300 projects**

**Including:**

- AM radio
- Radio announcer
- Lie detector
- Burglar alarm

**Contains over 60 parts**

**Including:**

- Two transistors
- Microphone
- Power amplifier IC
- Variable capacitor

## Snaptricity® Model SCBE-75



**Build over 75 projects**

Projects relate to electricity in the home and magnetism and how it is used.

**Contains over 40 parts**

**Includes:**

Meter, electromagnet, motor, lamps, switches, fan, compass and electrodes.

## Snap Circuits® Pro Model SC-500



**Build over 500 projects**

**Including:**

- Digitally tuned FM radio
- Adjustable light control
- Digital voice recorder
- AC generator

**Contains over 75 parts**

**Including:**

- Recording IC
- FM module
- Transformer
- Analog meter

## Deluxe Snap Rover® Model SCROV-50



**Features:**

- Disc shooter
- Digital voice recorder
- Music sounds
- Goes forward & backward
- Headlight
- Red & blue side lights
- Wireless remote control
- Left & right turning control

**Contains over 50 parts**

# SCG-125 Snap Circuits® Green Block Layout

**Important:** If any parts are missing or damaged, **DO NOT RETURN TO RETAILER.**

Call toll-free (800) 533-2441 or e-mail us at: [help@elenco.com](mailto:help@elenco.com). Customer Service • 150 Carpenter Ave. Wheeling, IL 60090 U.S.A. **Note:** A complete parts list is on page 2 in this manual.

